



Logic

Space



Coding



Focus

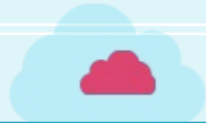

Classroom Discipline

01

Please sit down and keep quiet in class.

02

Please raise your hand if you have any questions

03

Please observe carefully when the pictures are played.



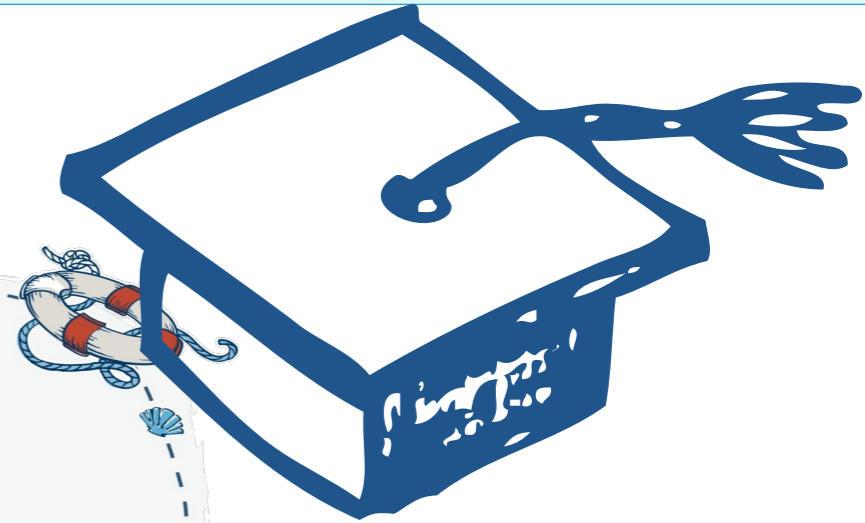
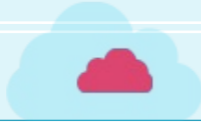

Expansion Clamp





Think

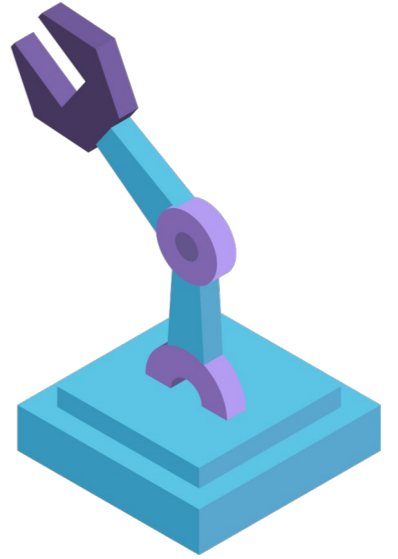



1. Do you know what environmental volunteers are?
2. How do they help us protect the environment?





Explore

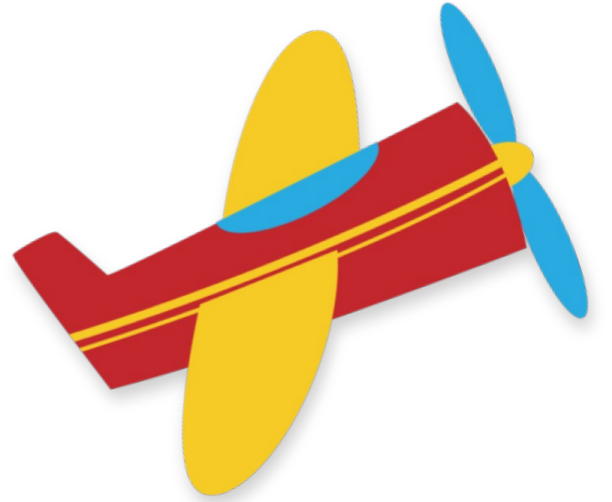

1. What ideas do you have to make volunteering less stressful?





Build

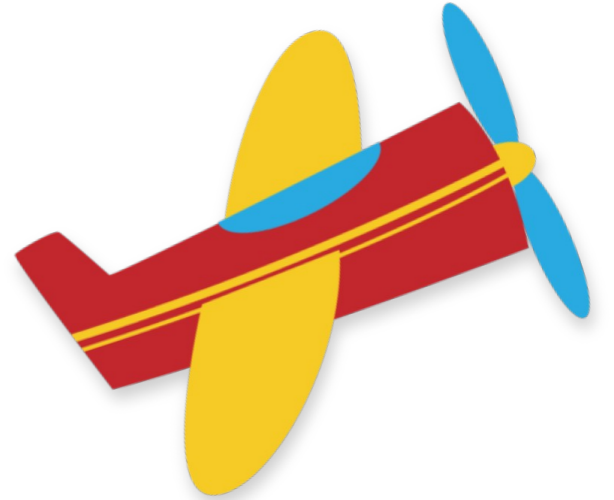

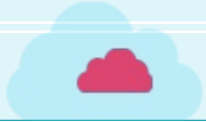

Clamp mounth

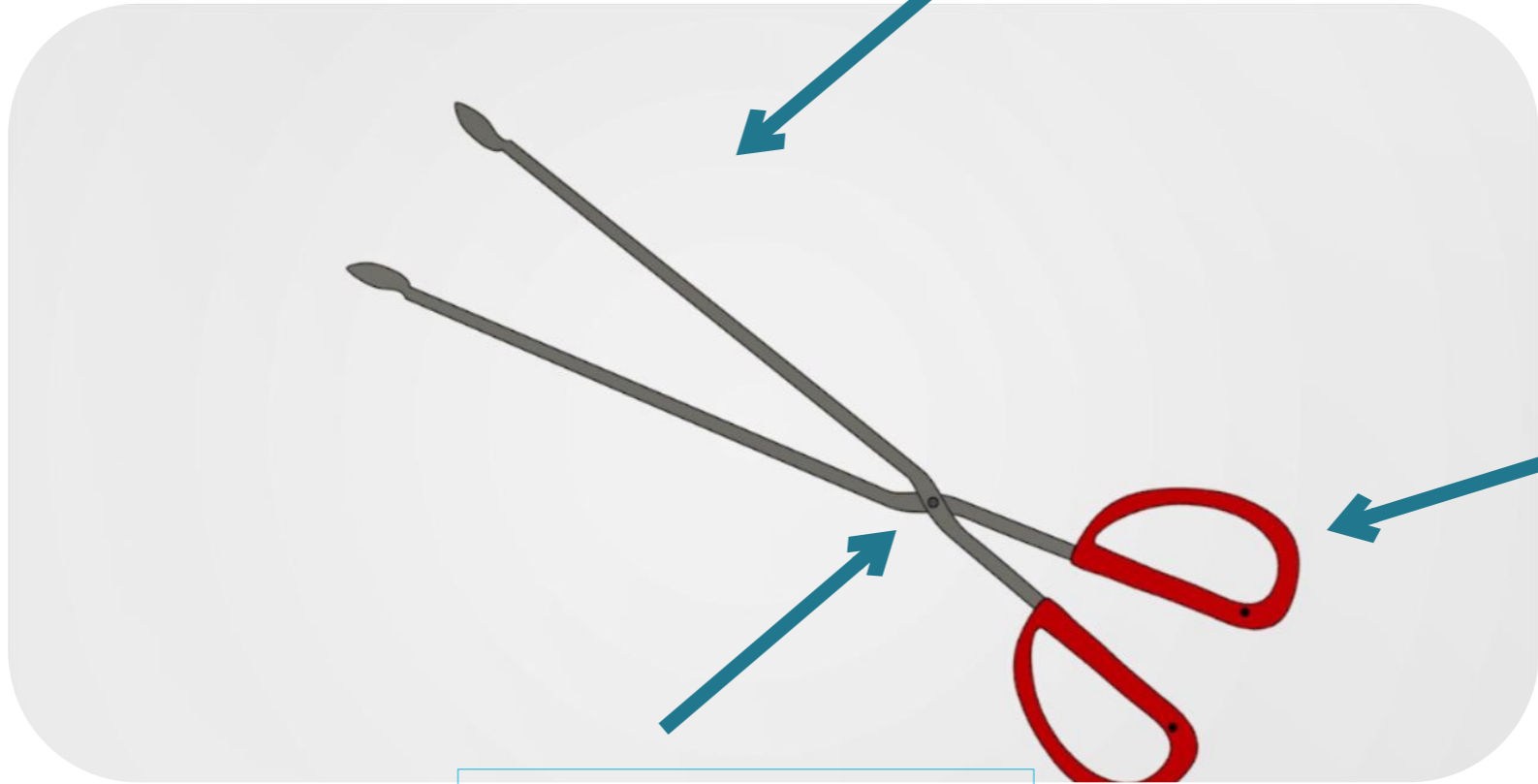

handle

Fulcrum axis

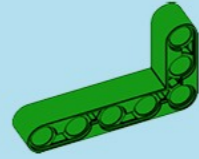
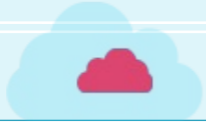

x1



x4

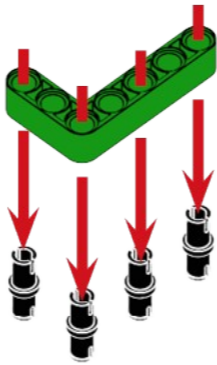

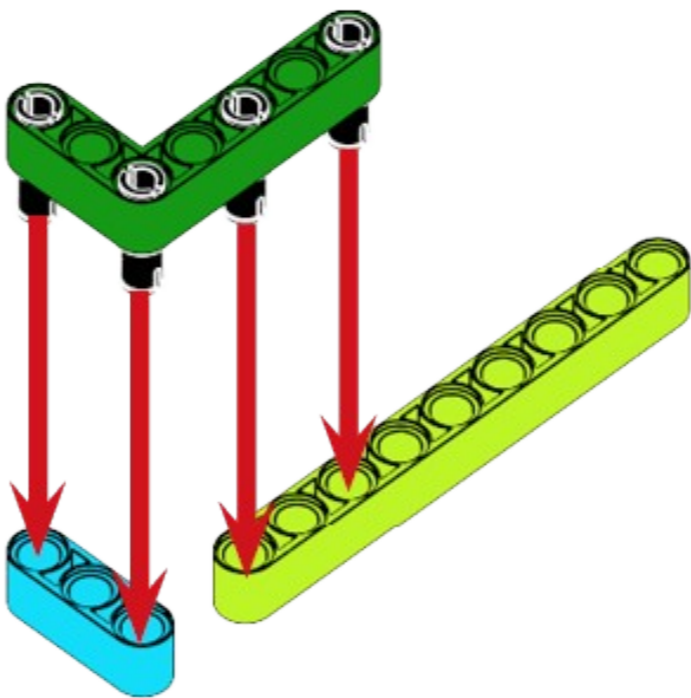

9

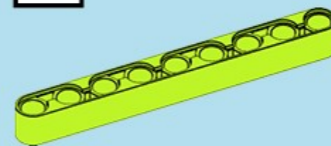

x1

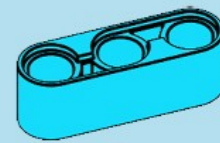

x1

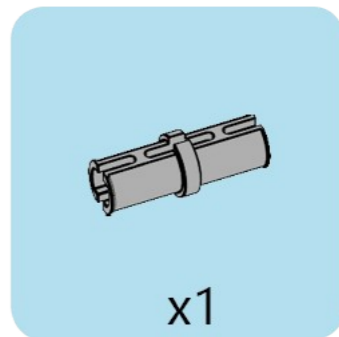
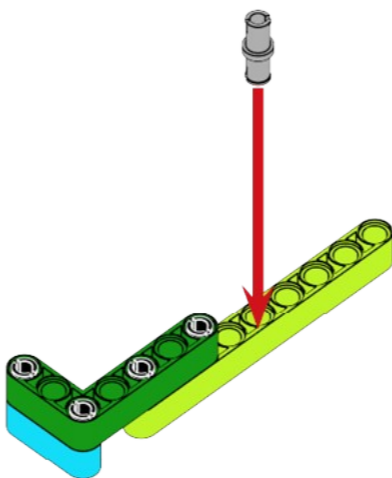

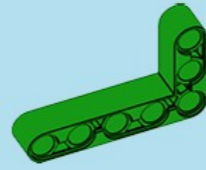
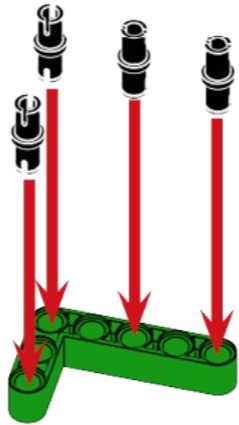

x1



x4

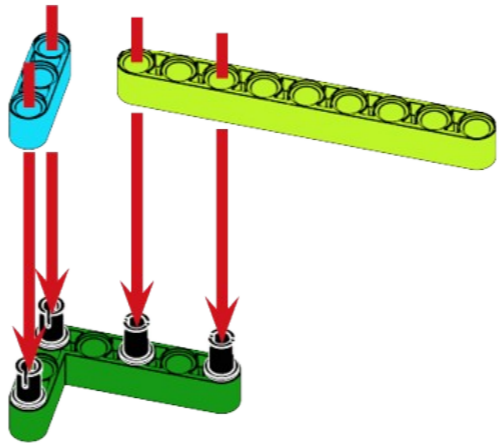

9

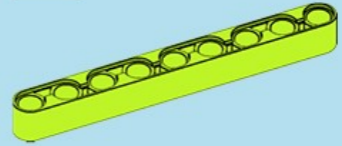

x1

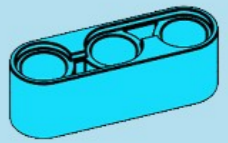

x1

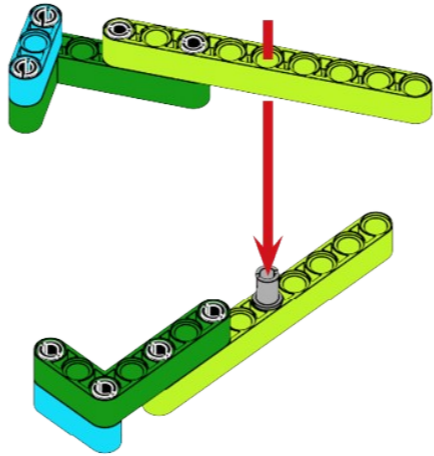
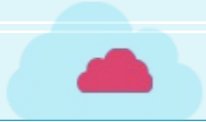

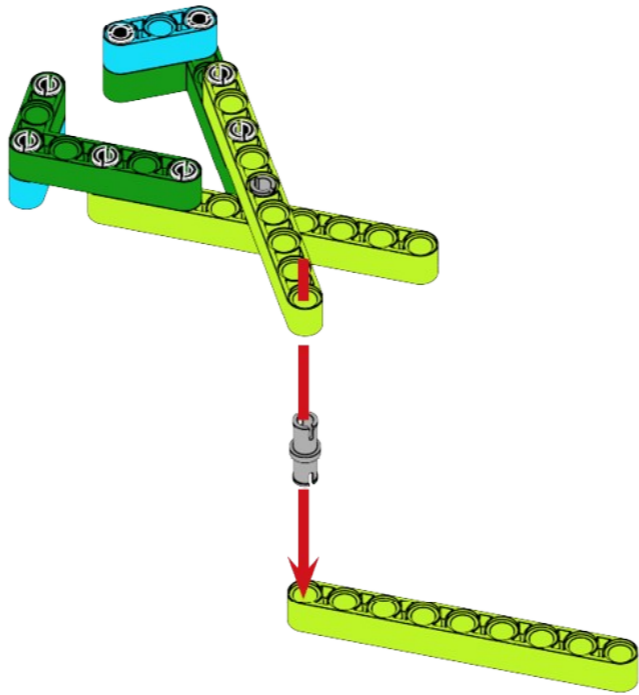
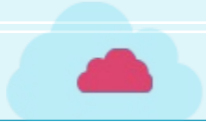

9

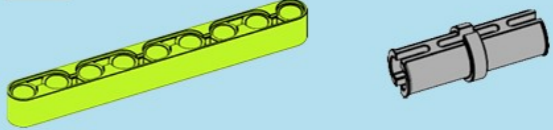

x1 x1

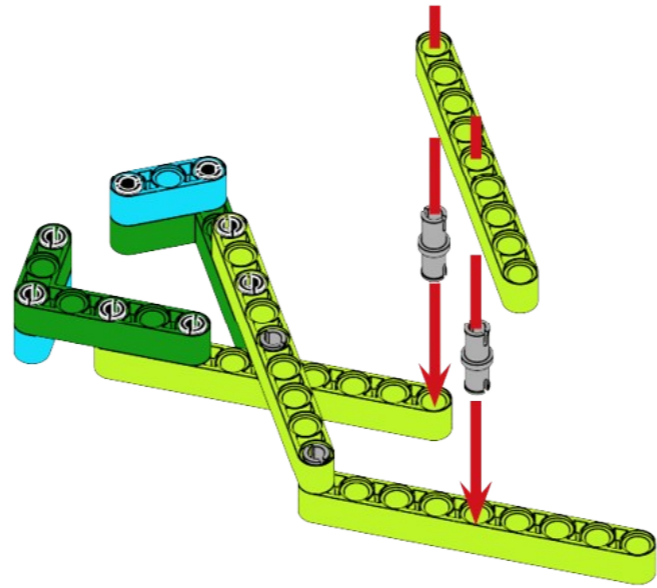
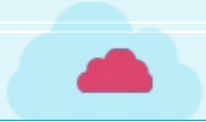

9

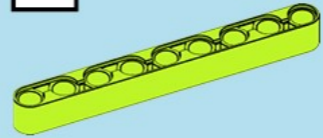

x1

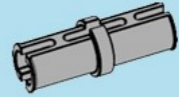

x2

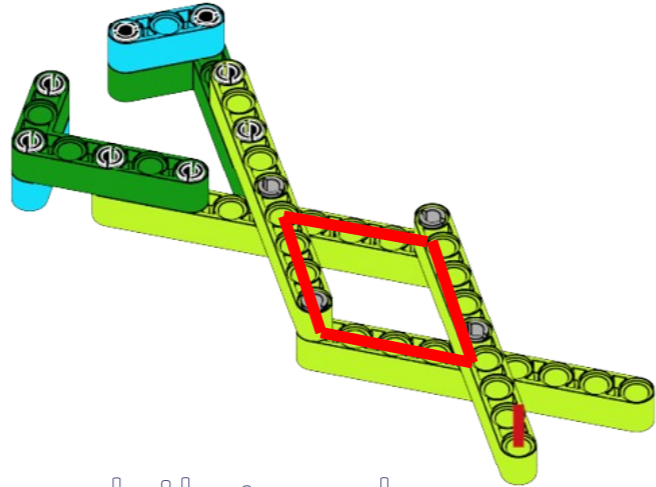
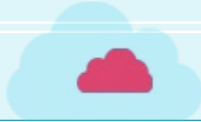

Quadrilateral
structure

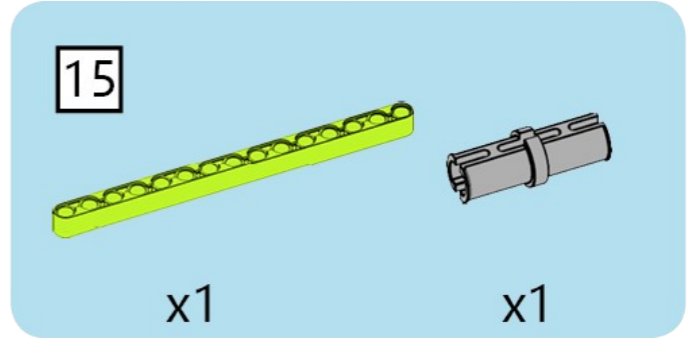
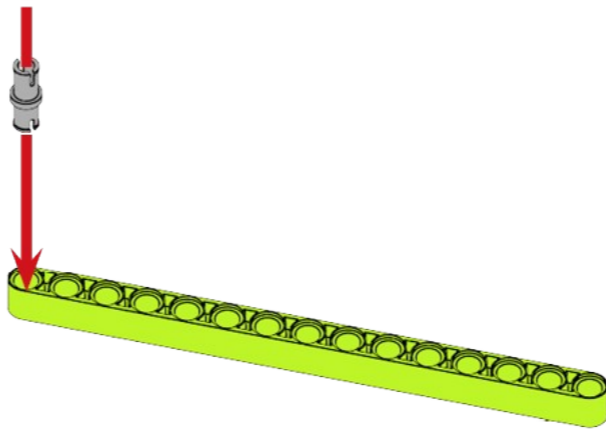

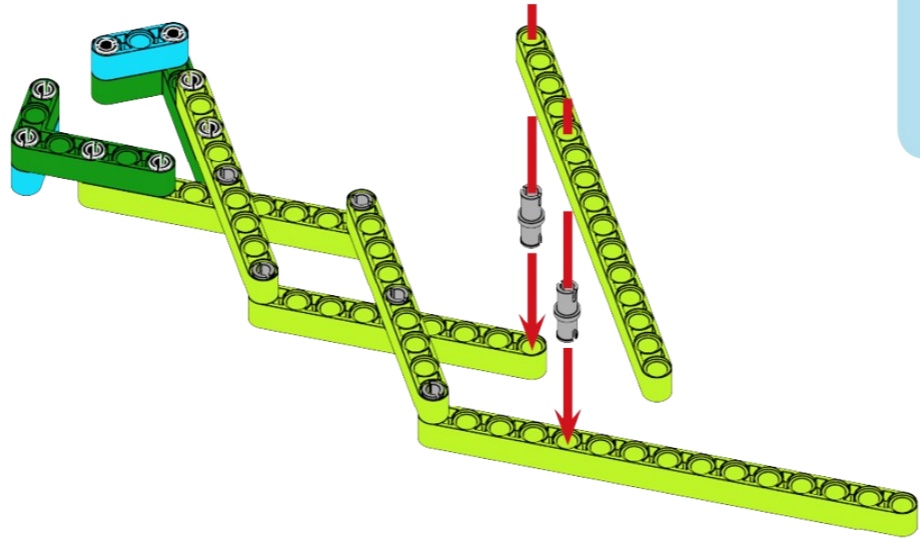
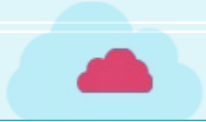

15

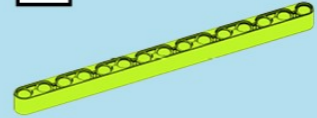

x1

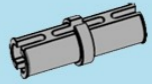

x2

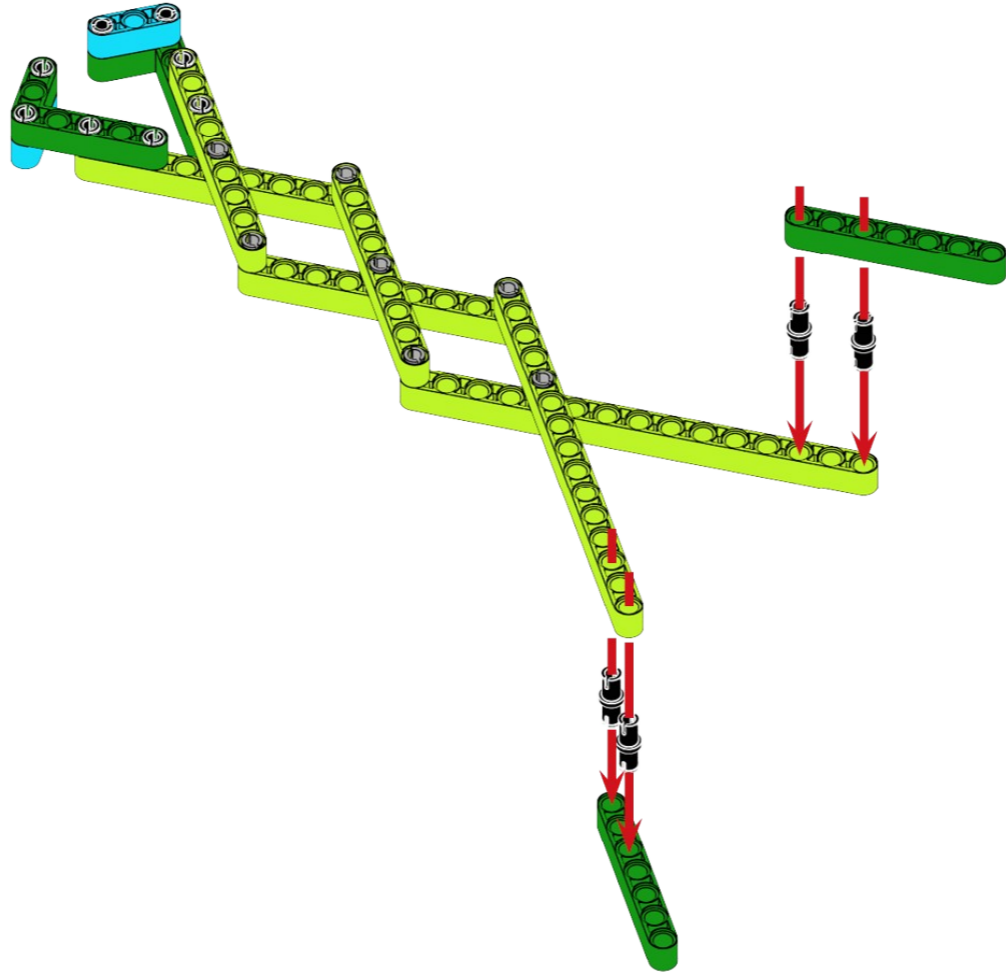

7

x2 x4

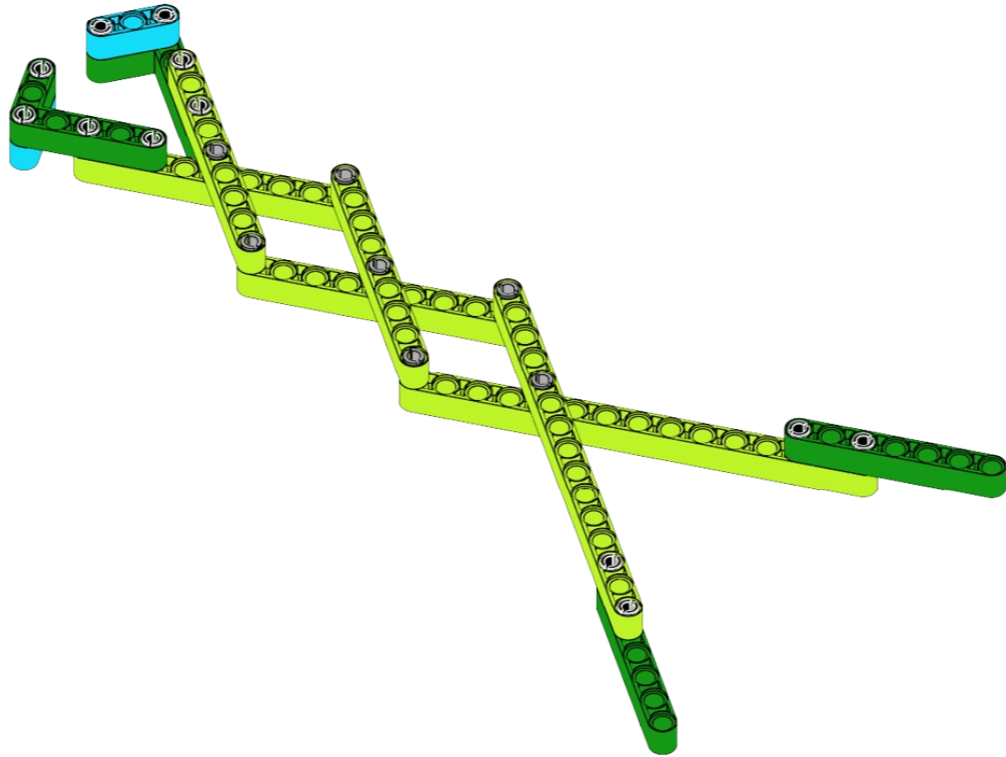

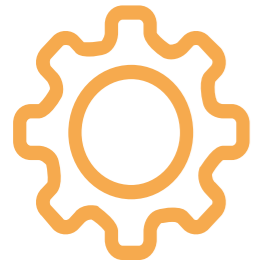

Review

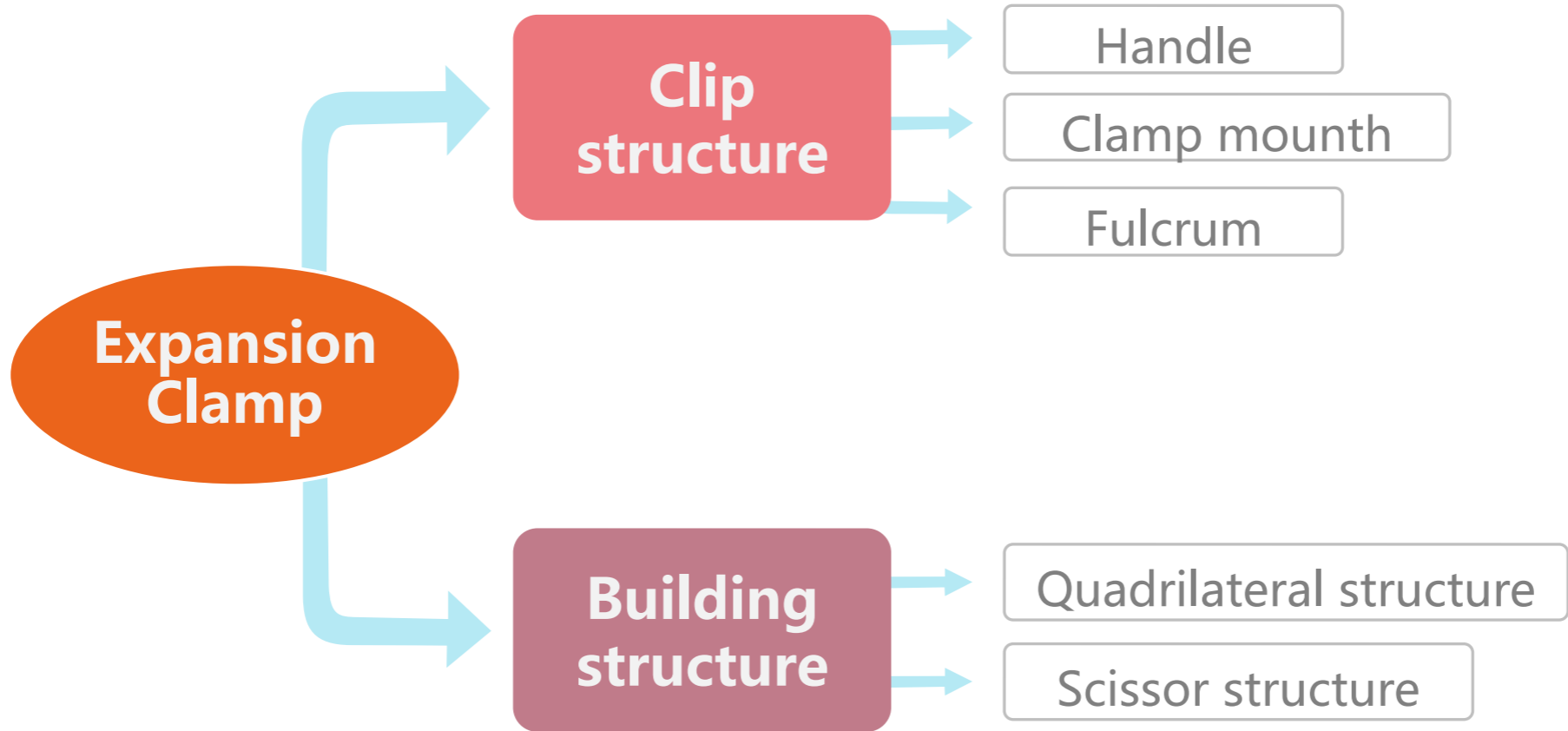

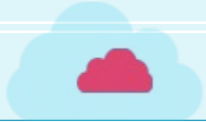

Talk





THANKS

