



Logic

Space



Coding



Focus

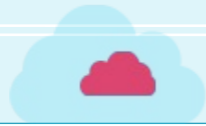

Classroom Discipline

01

Please sit down and keep quiet in class.

02

Please raise your hand if you have any questions

03

Please observe carefully when the pictures are played.



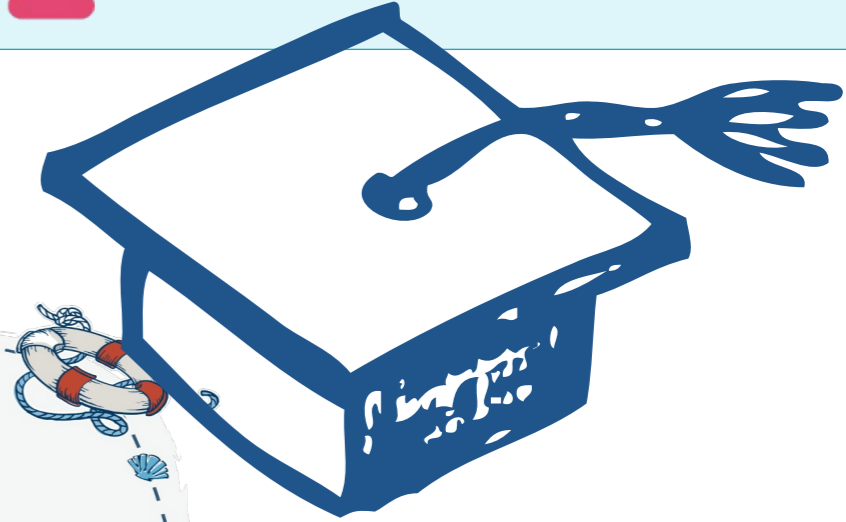
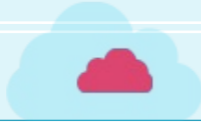

The Funny Seesaw





Think

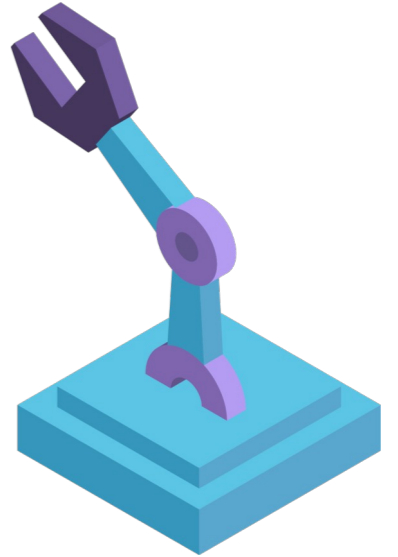

1. Can you tell me what games there are in the amusement park?





Explore

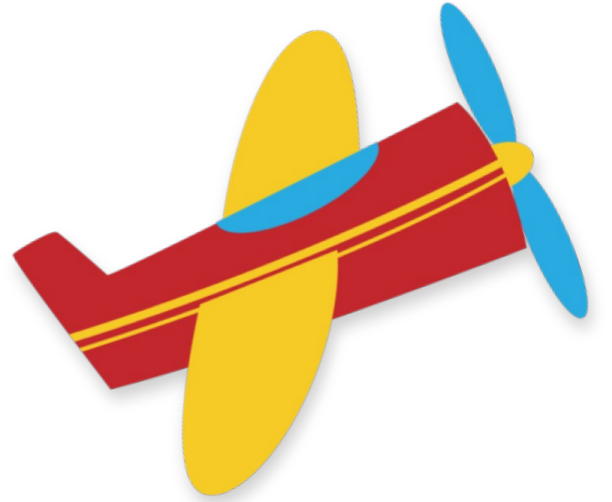

1. Why is the girl on the right being lifted up?
2. What happens if the girl sits back a little?
Let's see.

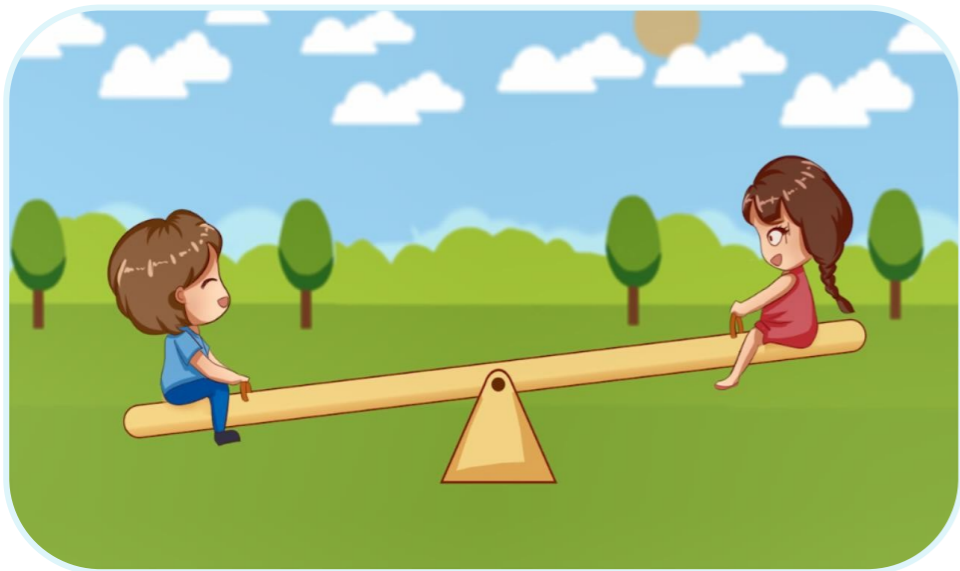

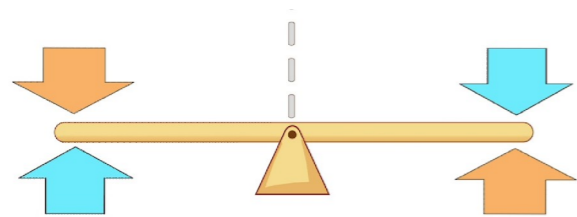

Equal-arm lever

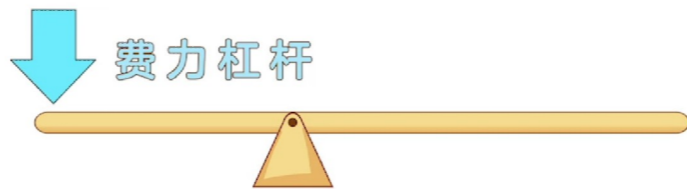

费力杠杆

Disadvantaged lever



省力杠杆

advantaged lever

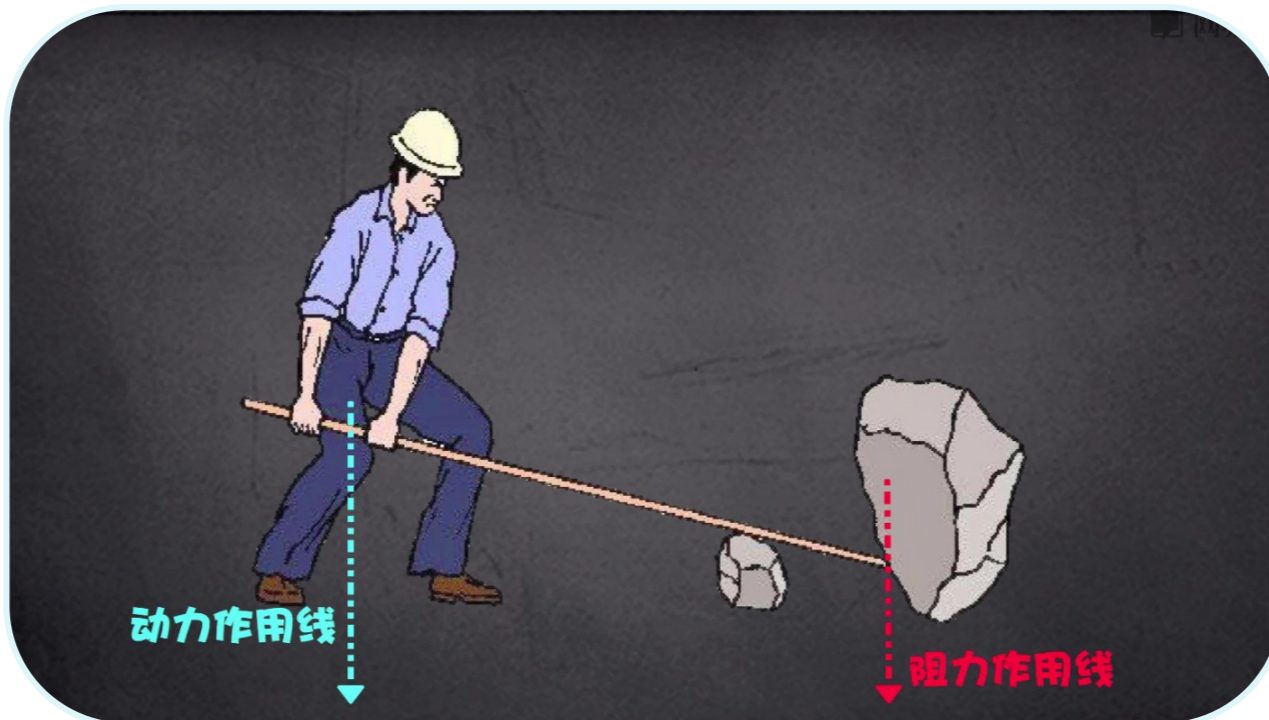

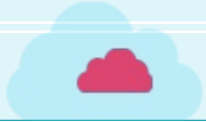

Build

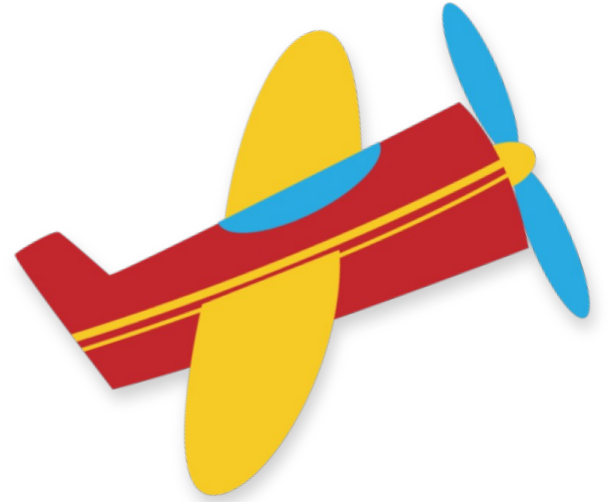



Long pole

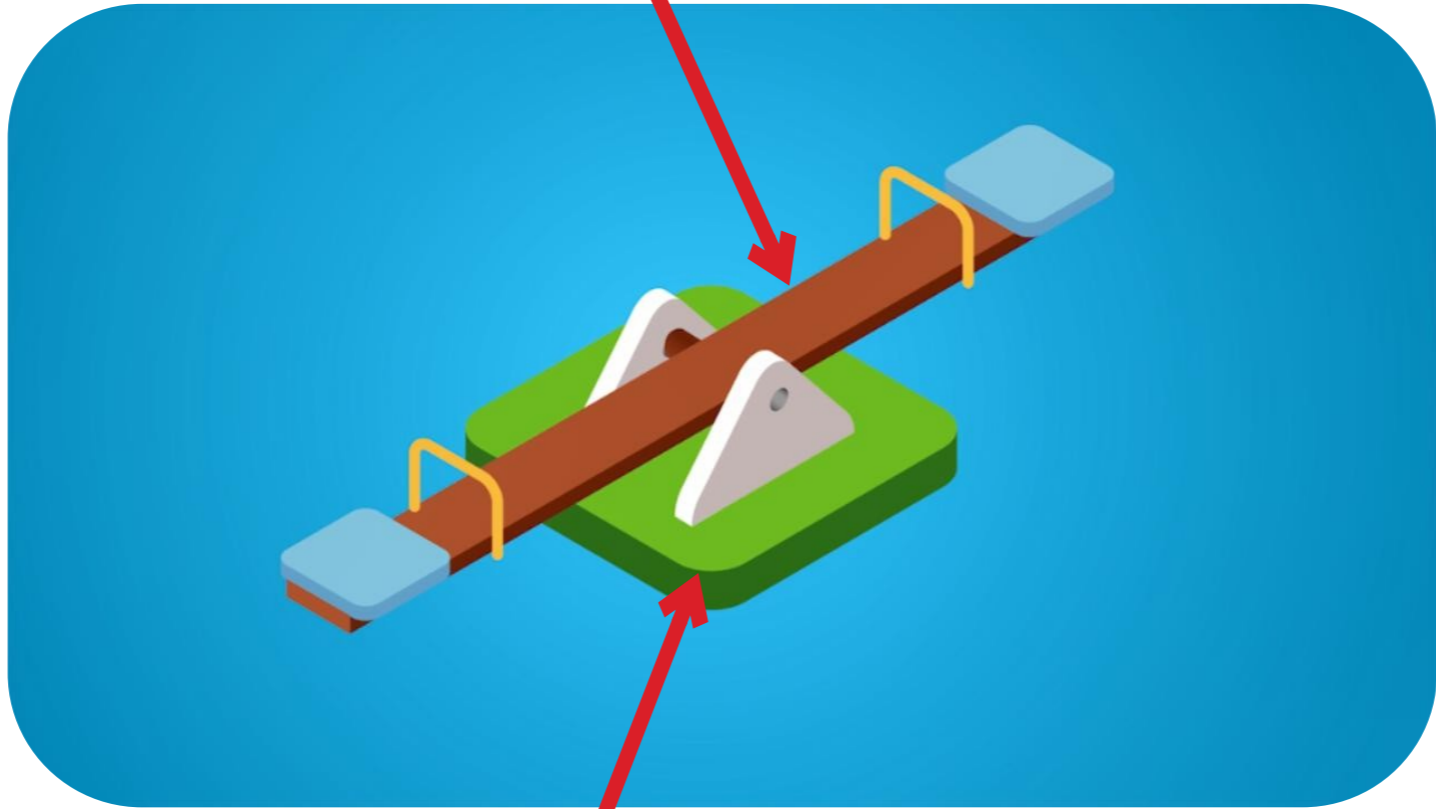

Bas

e

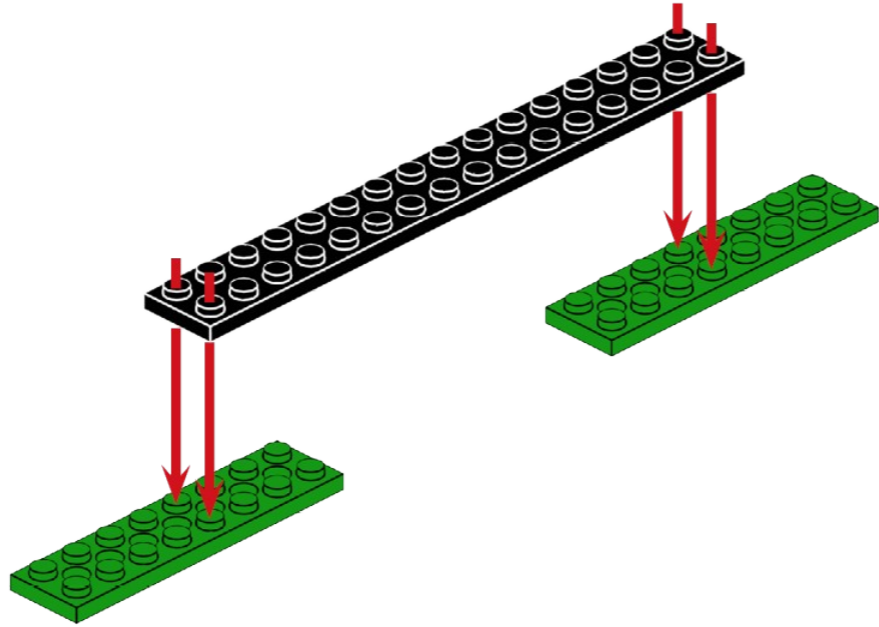
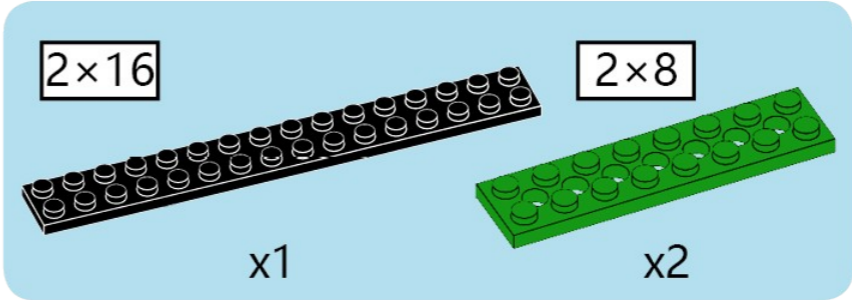

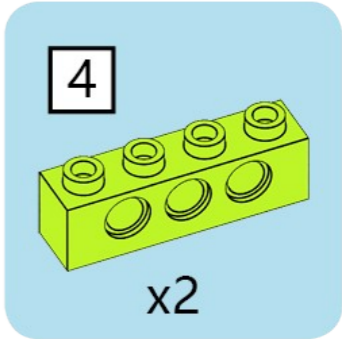
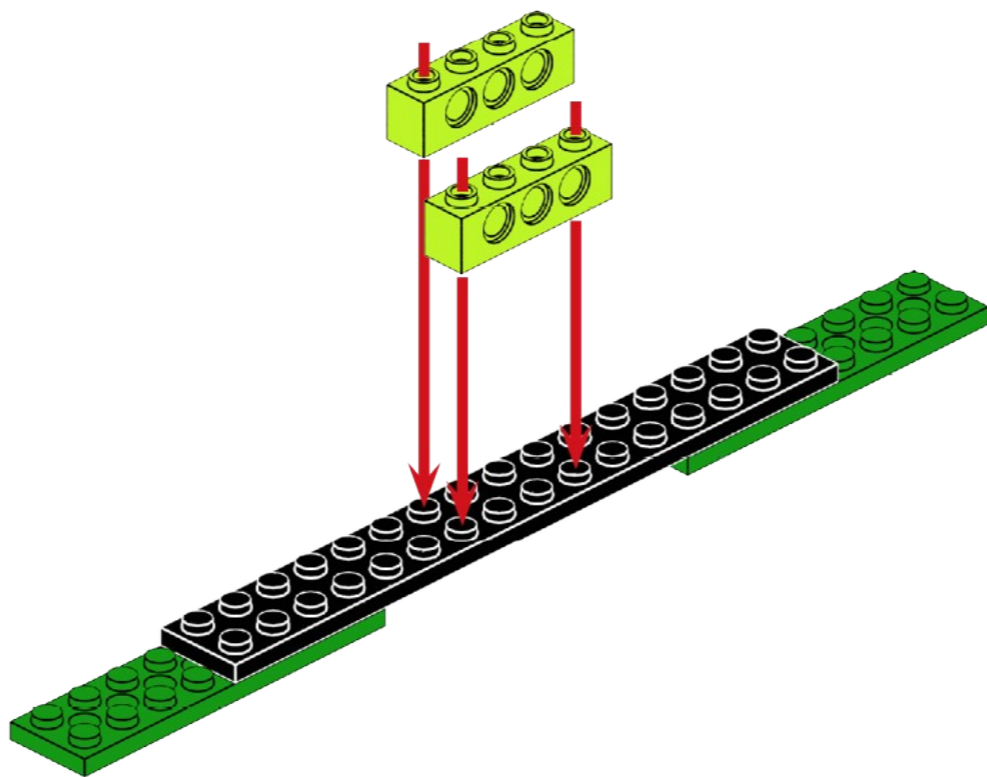

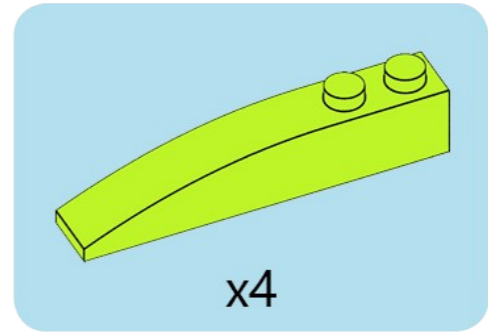
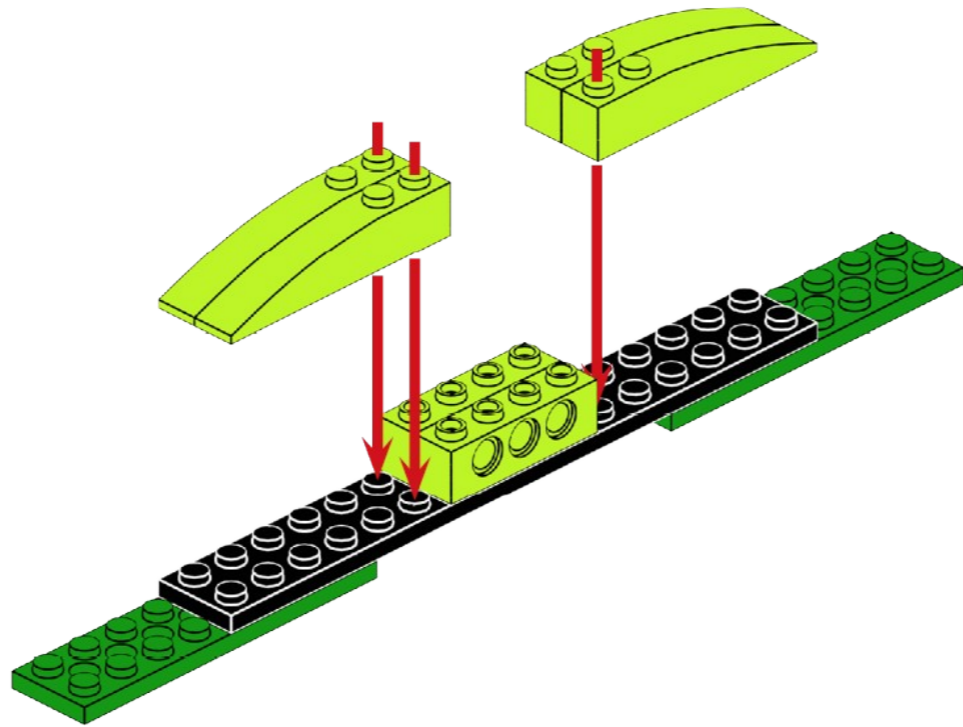

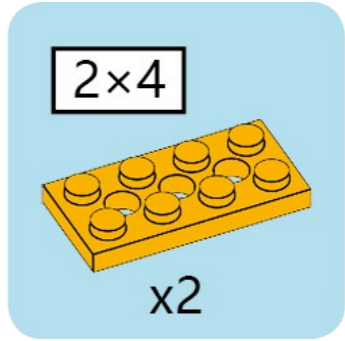
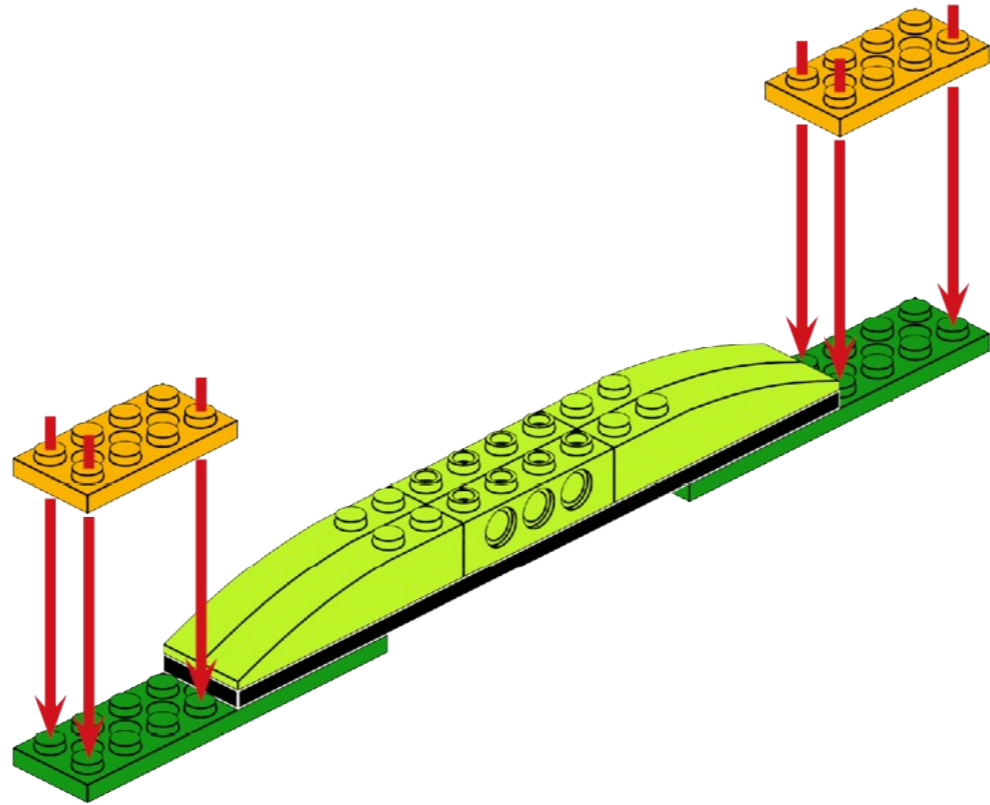

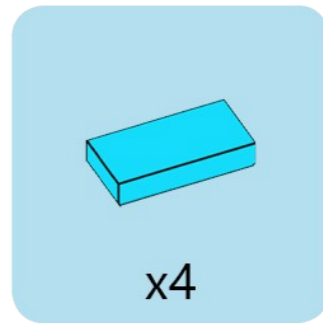
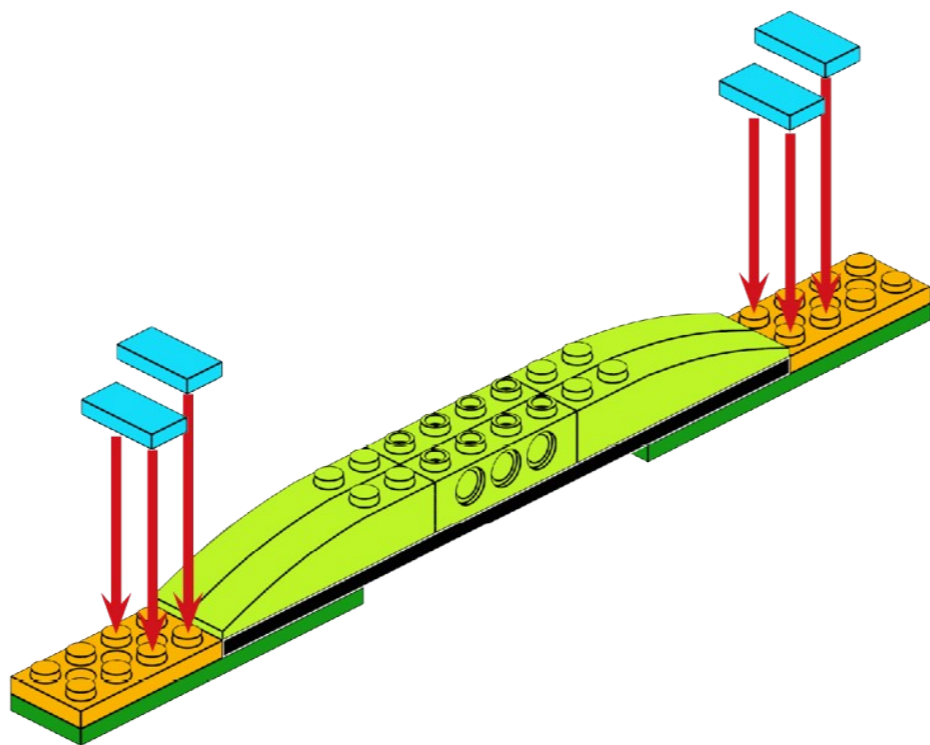

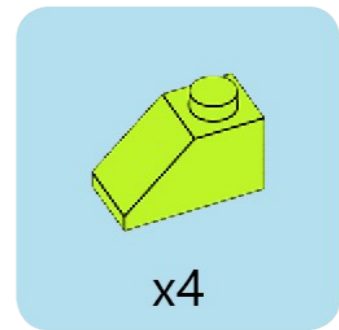
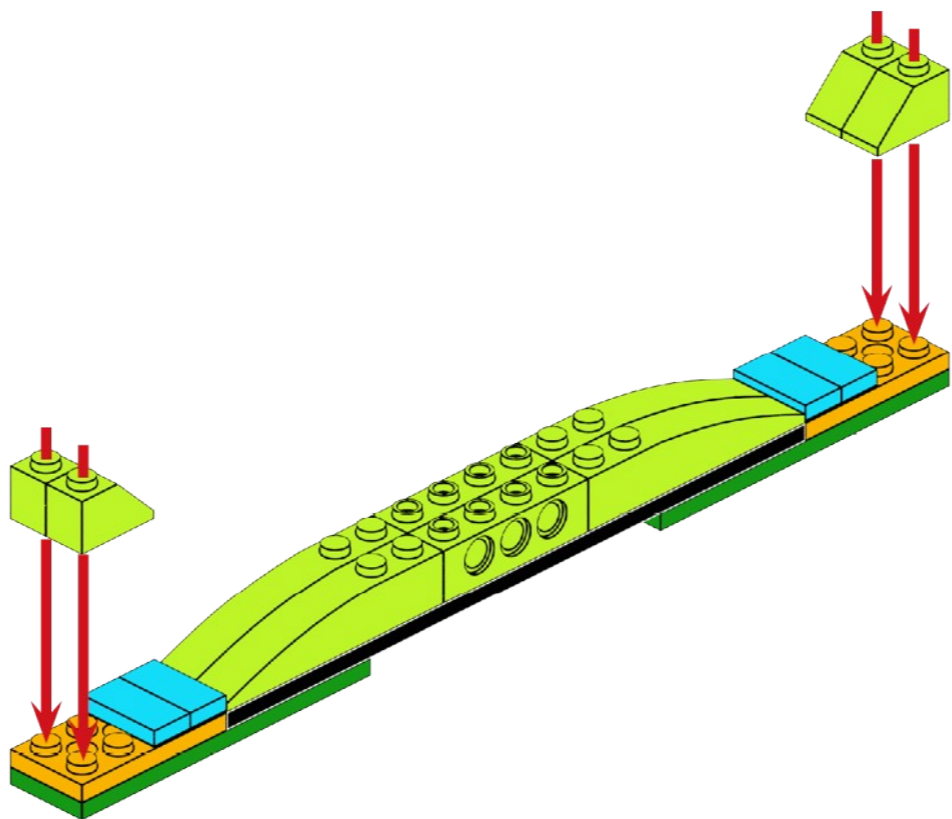

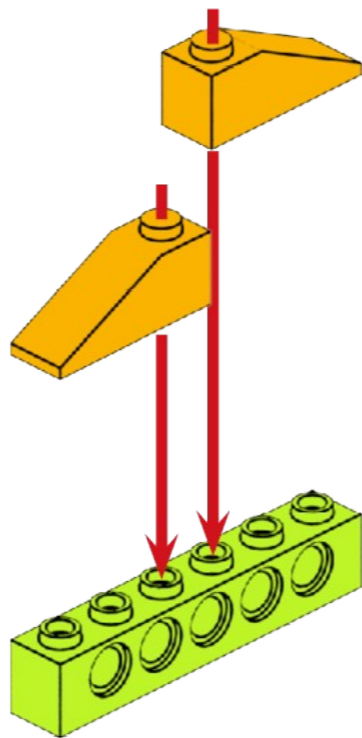

6

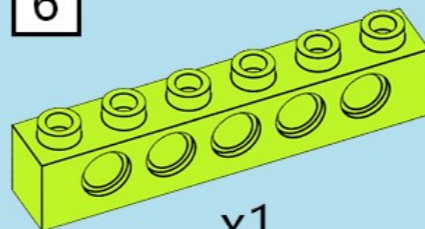

x1

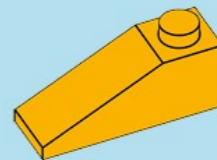

x2

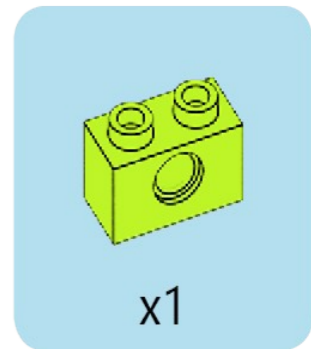
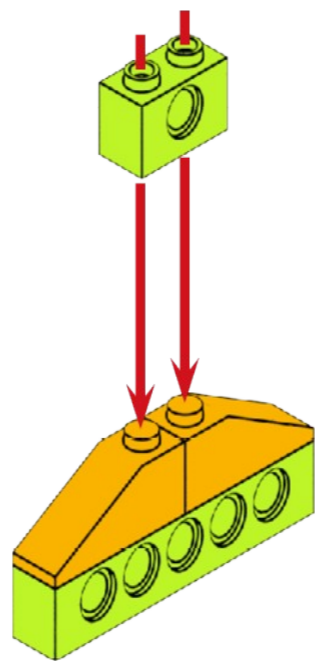

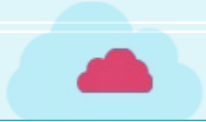

6

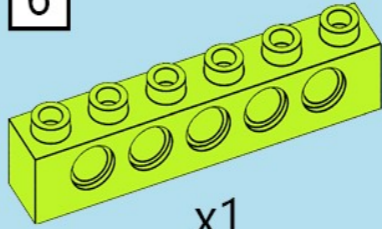

x1

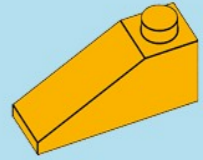

x2

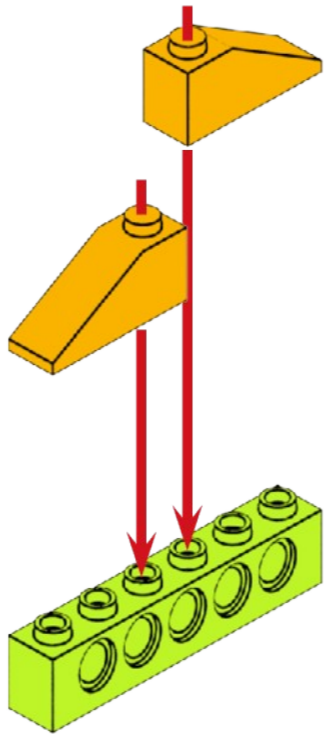

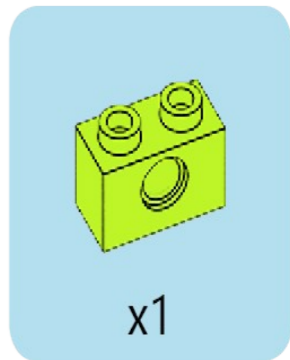
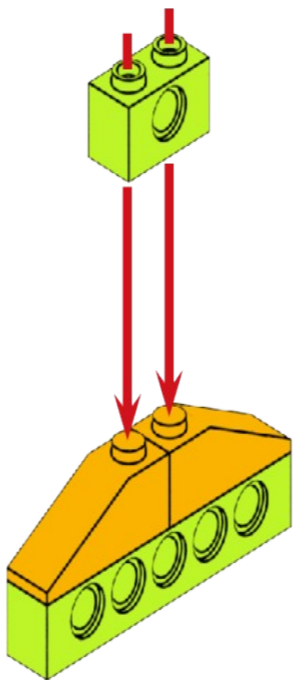

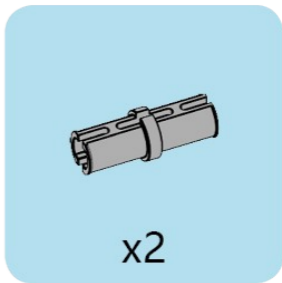
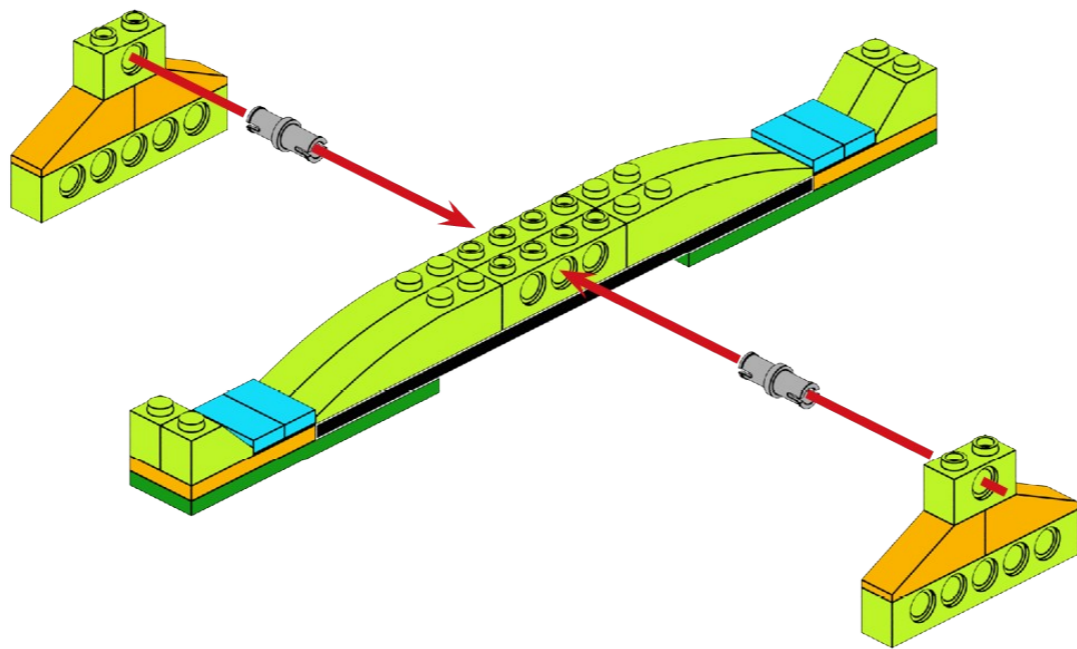

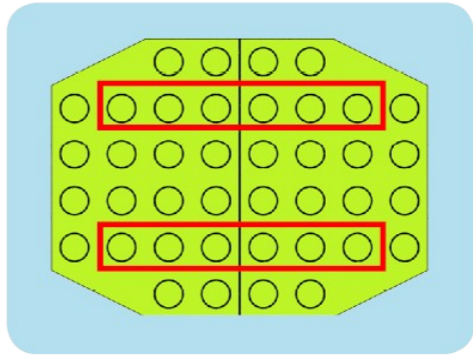
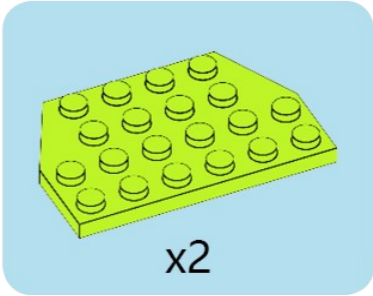
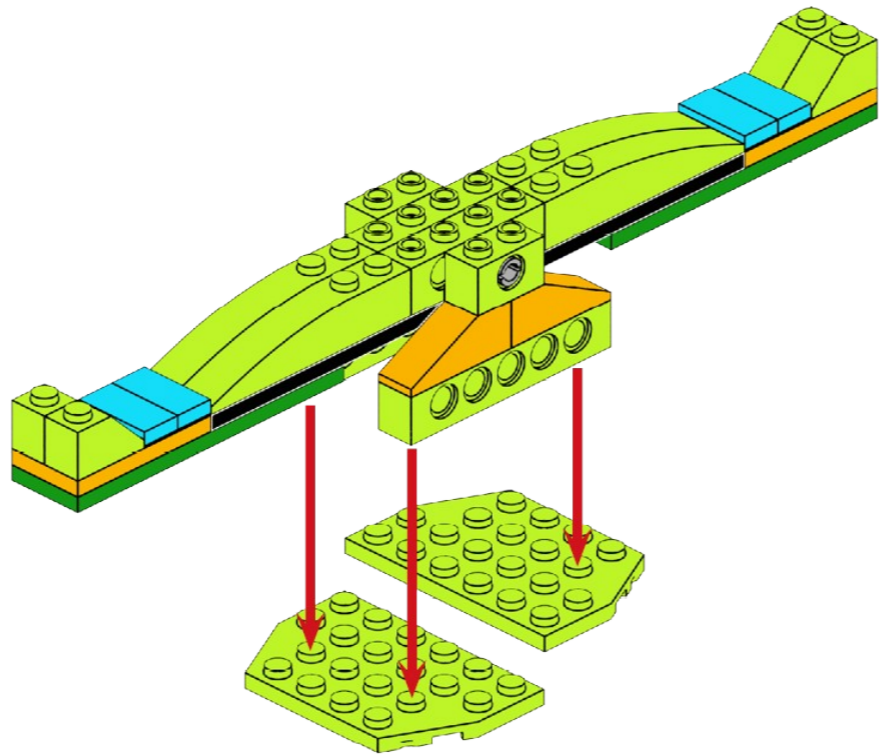

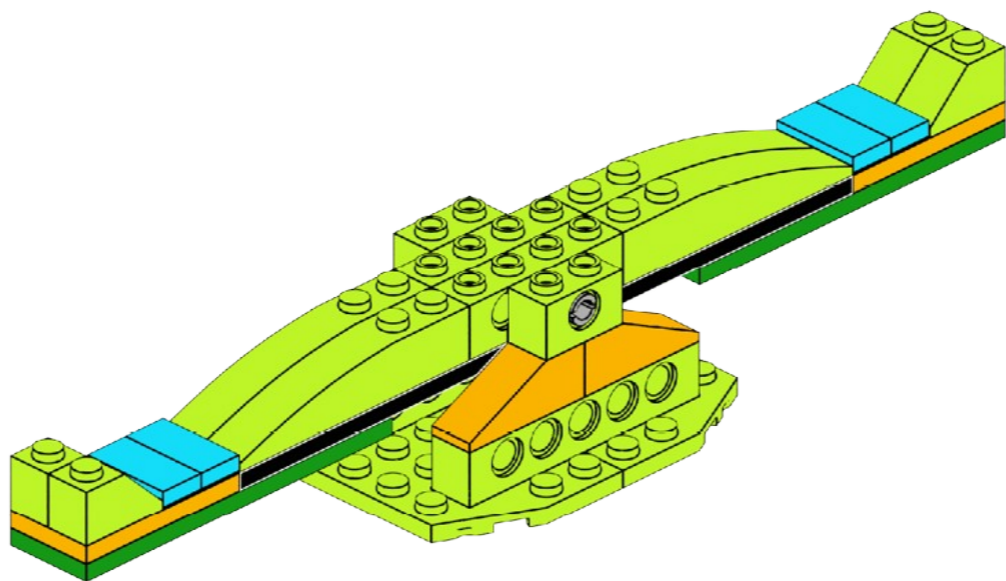

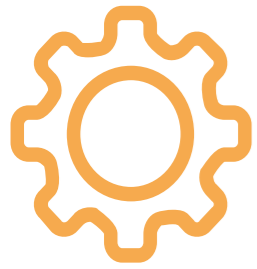

Review

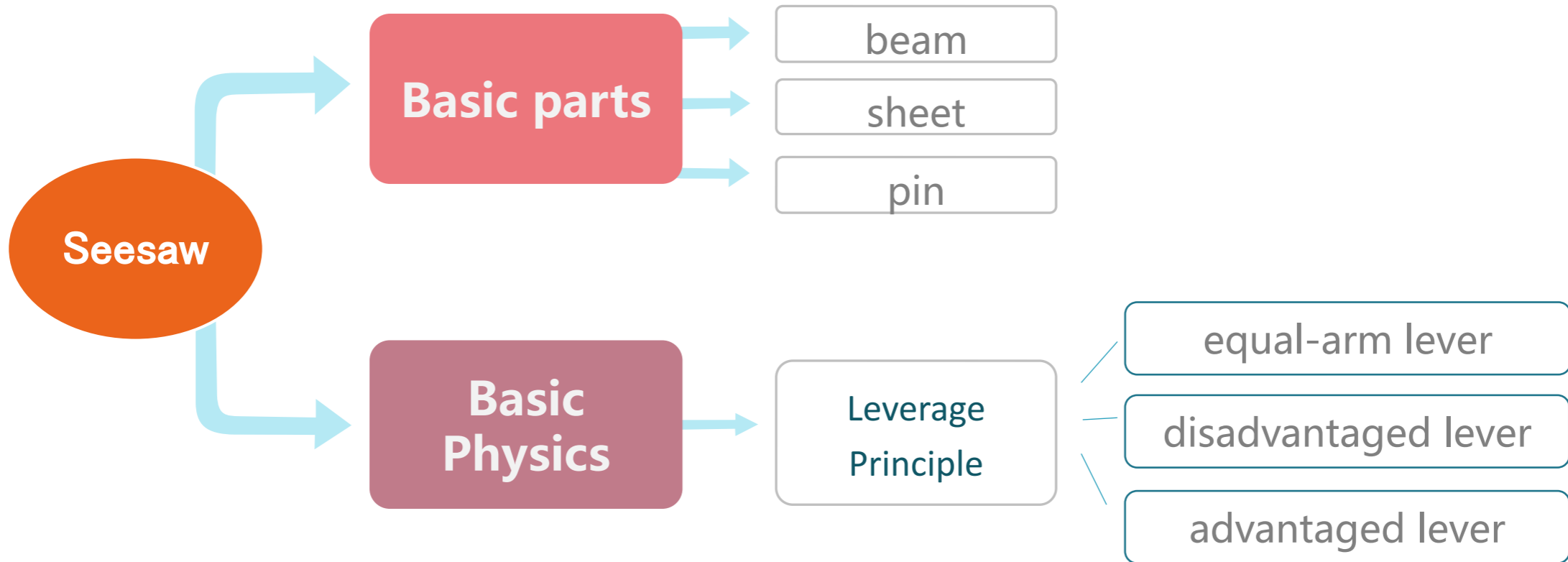

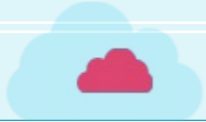

Talk

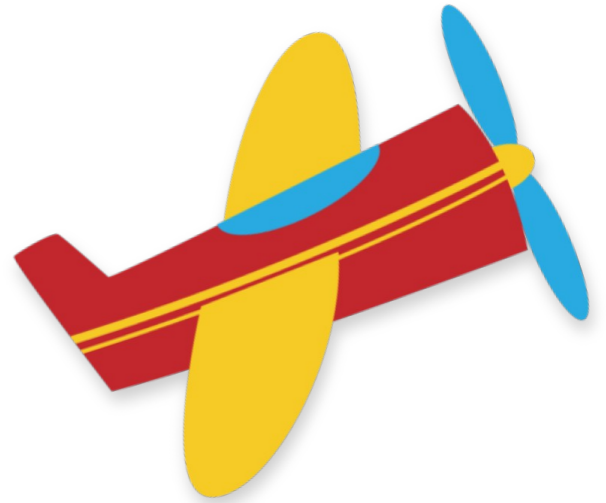



THANKS

