



Logic

Space



Coding



Focus

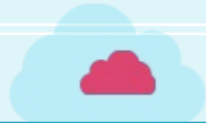

Classroom Discipline

01

Please sit down and keep quiet in class.

02

Please raise your hand if you have any questions

03

Please observe carefully when the pictures are played.



The Funny Tumbler

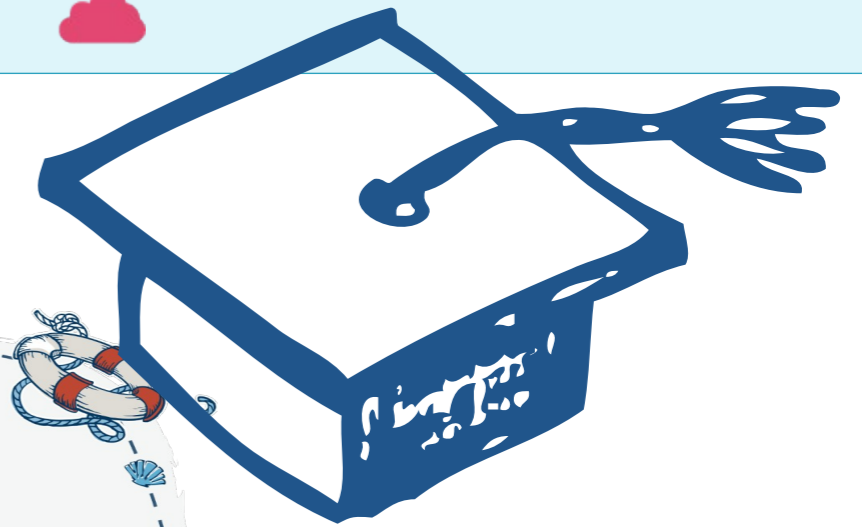



Think

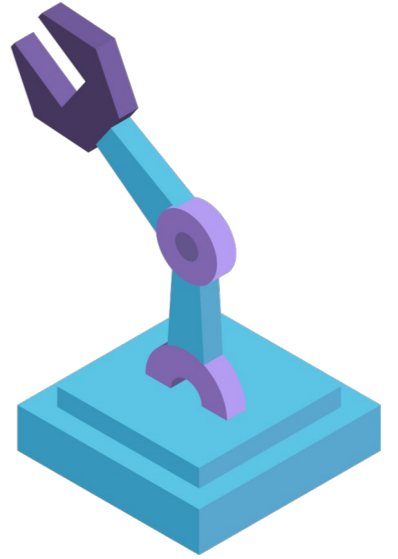

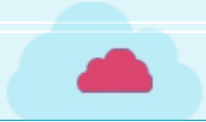

1. What are your favorite toys?

2. Have you ever played with a tumbler?





Explore

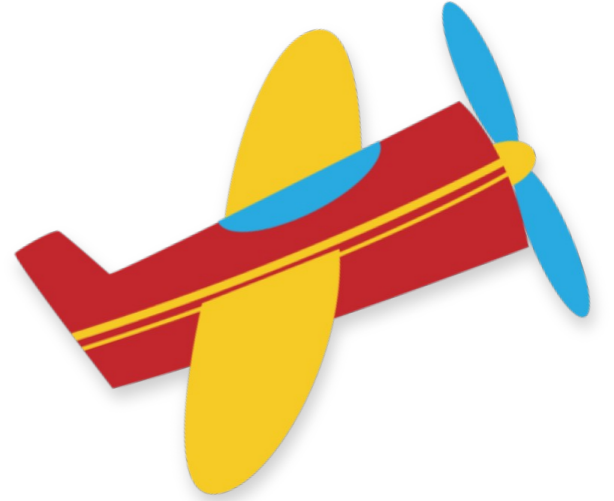

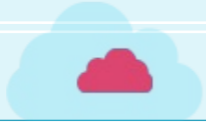

1. What happens when we push the tumbler?

2. Why doesn't the tumbler fall down?





Build

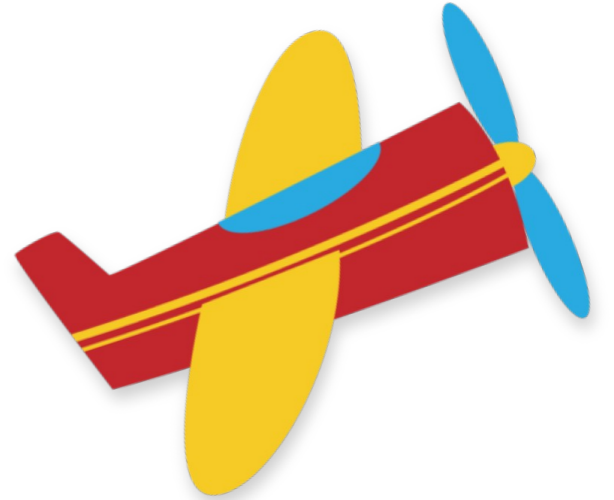

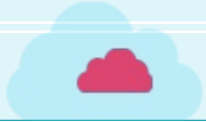

12

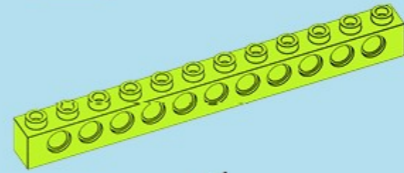

x1



x2

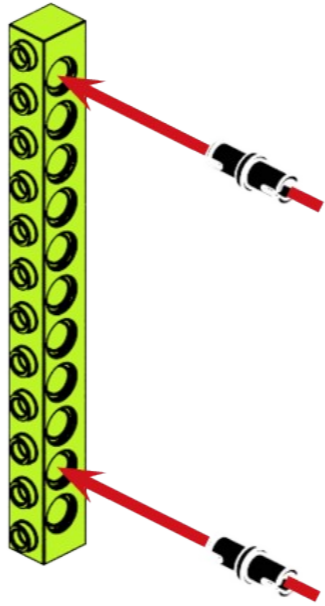

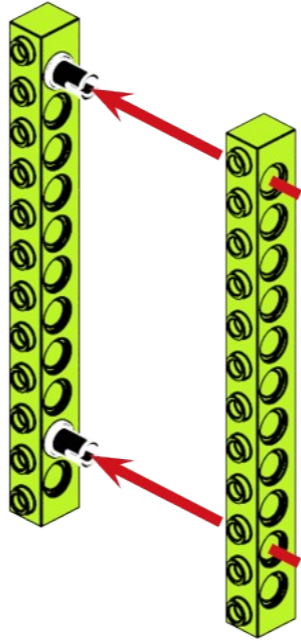
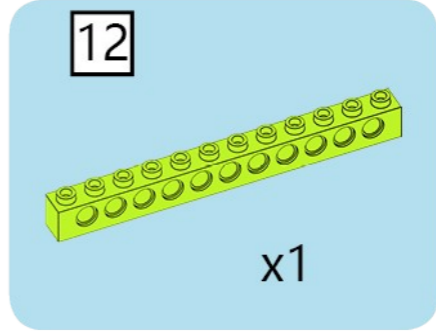

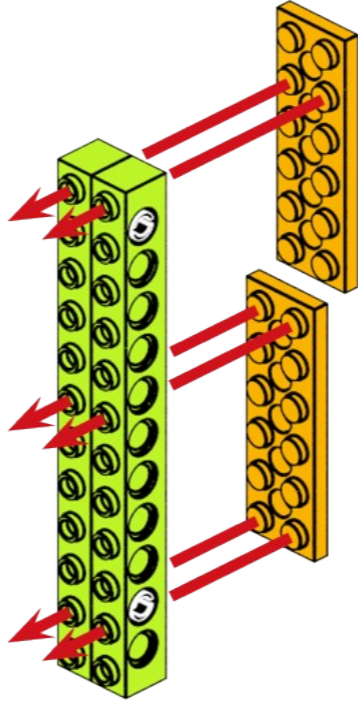

2x6

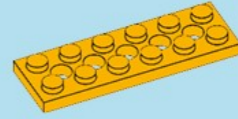

x2

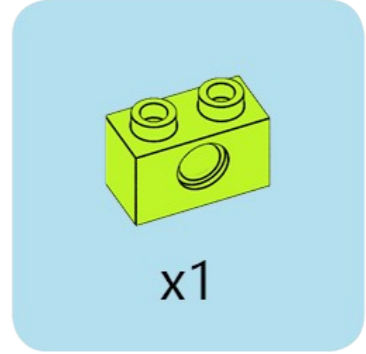
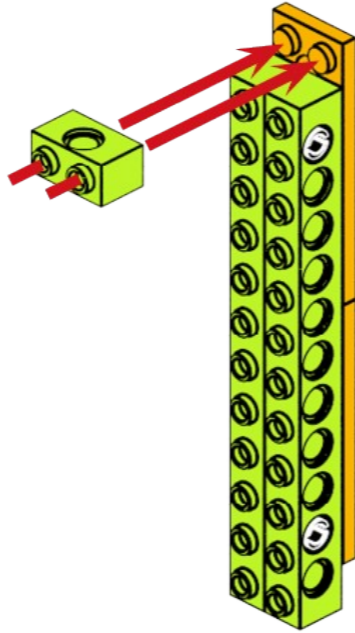
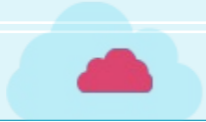

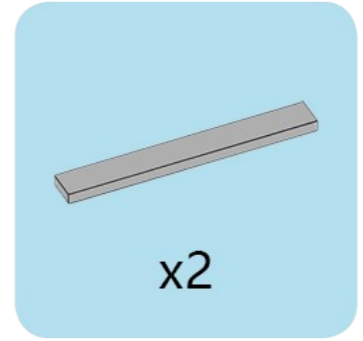
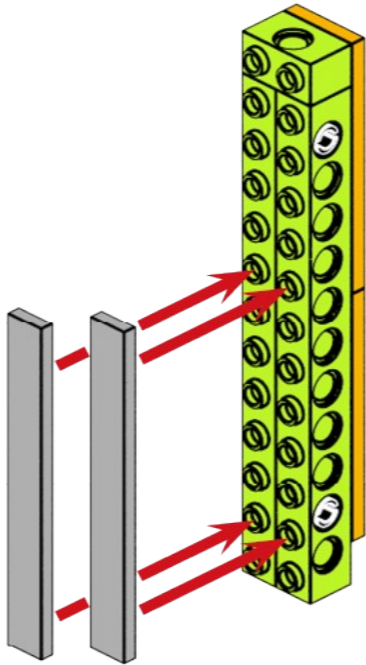

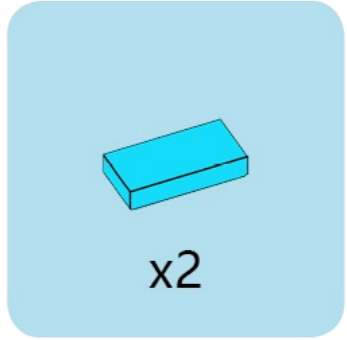
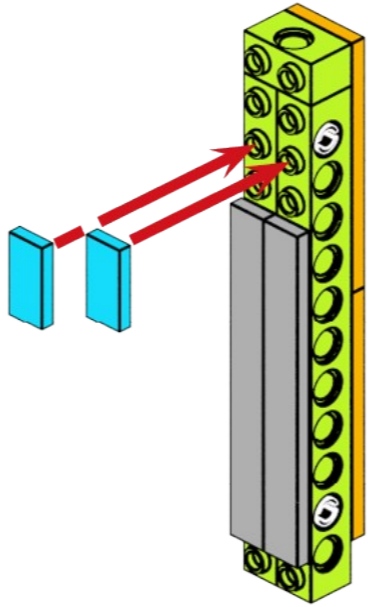

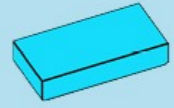
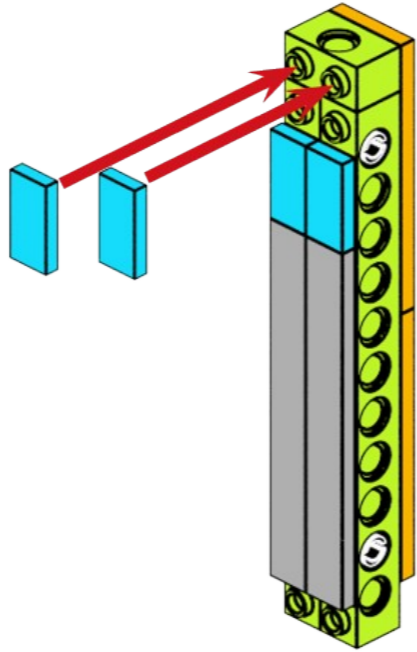
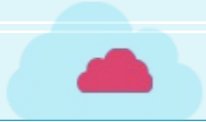

x2

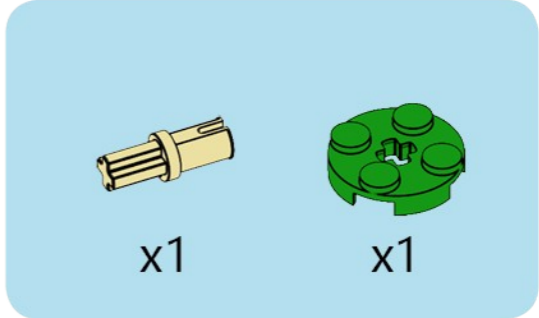
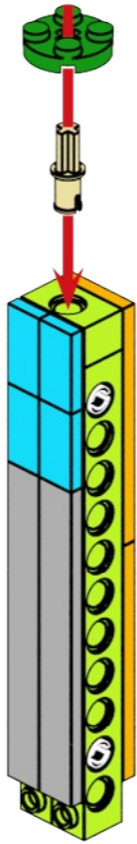
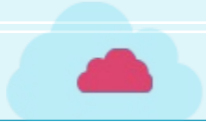

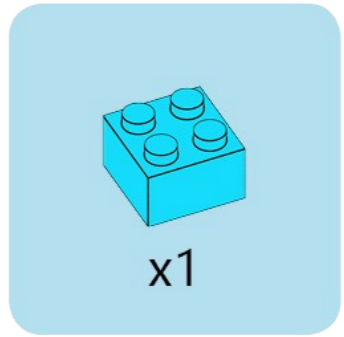
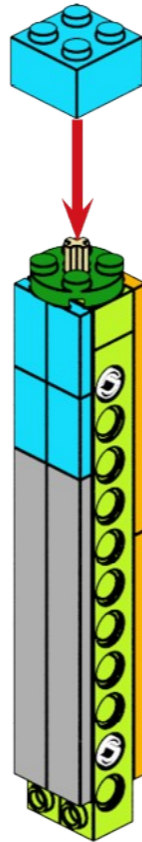
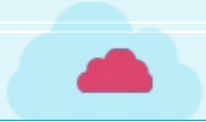

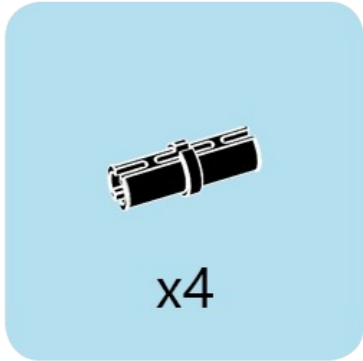
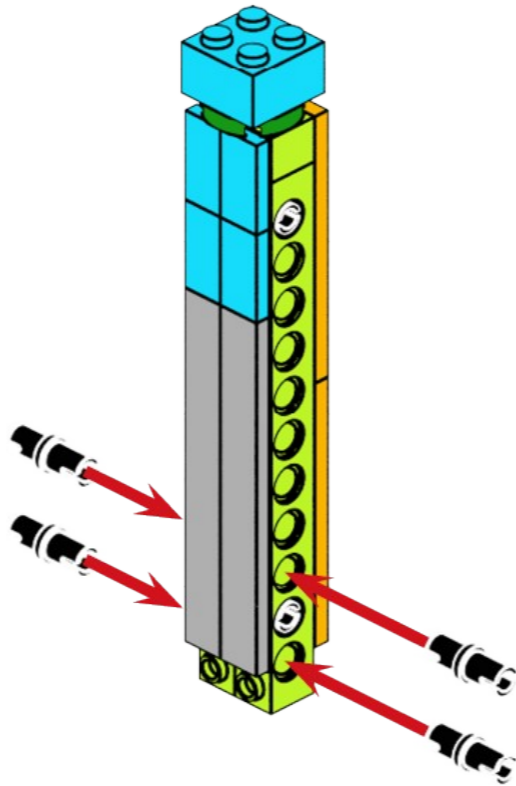
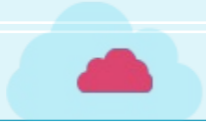

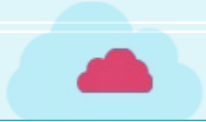

8

1x6

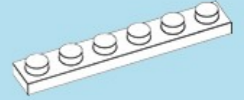
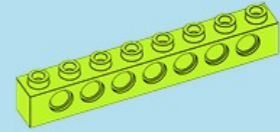

x1

x1

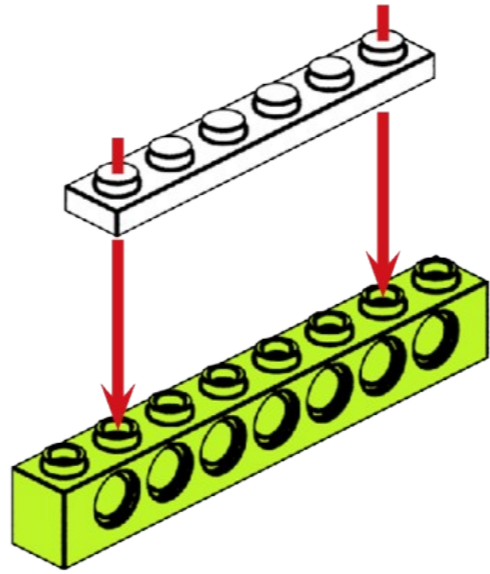

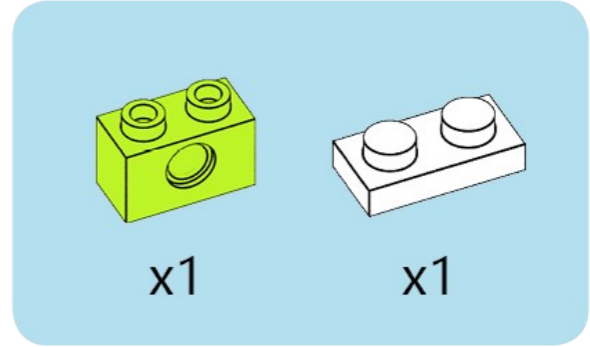
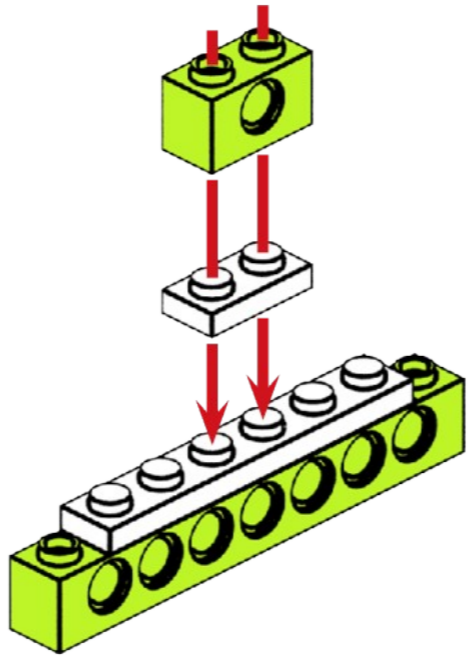

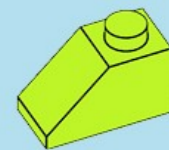
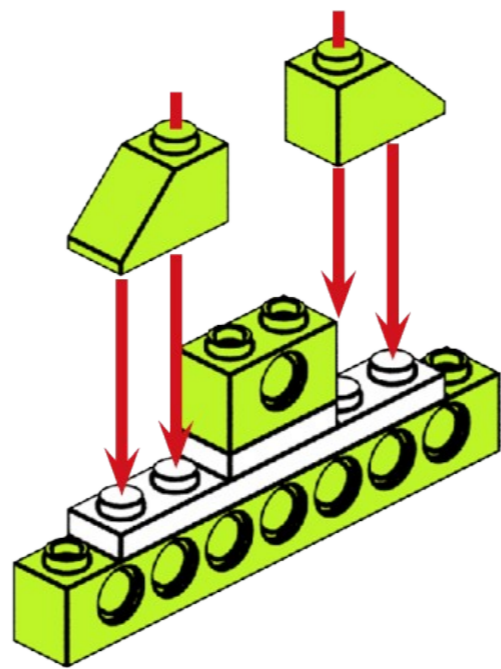

x2

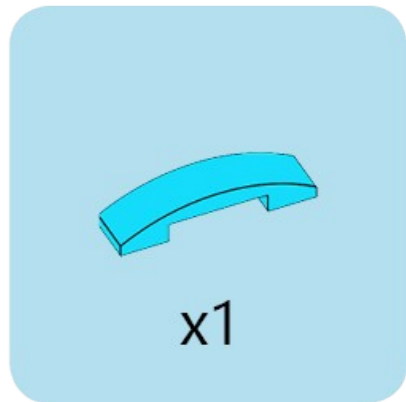
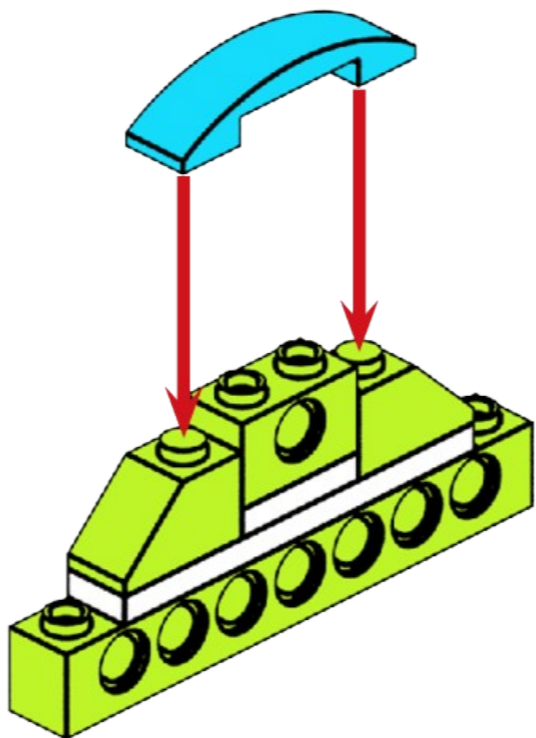

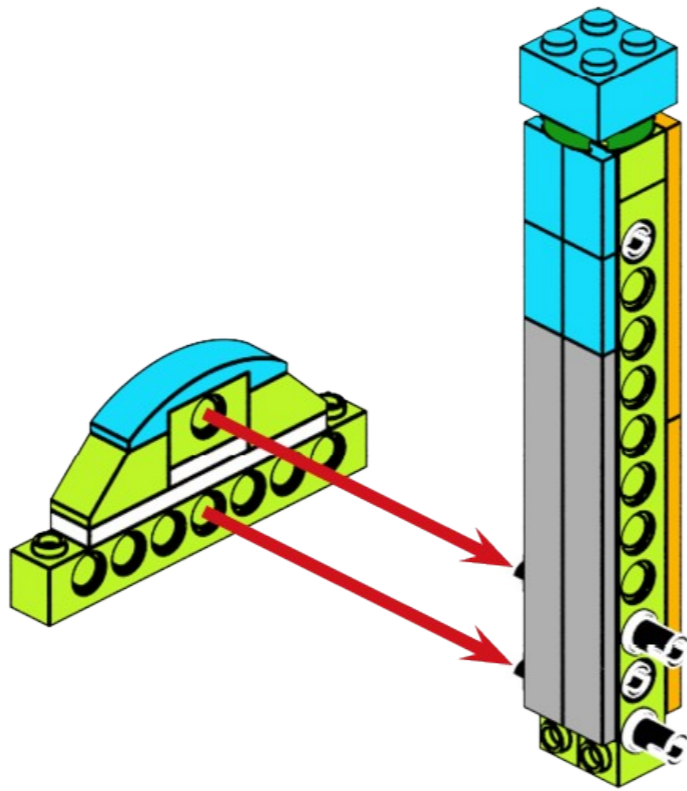
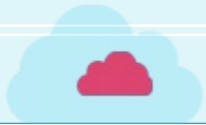



8

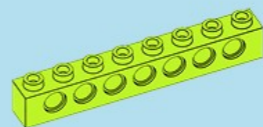

x1

1x6

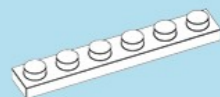

x1

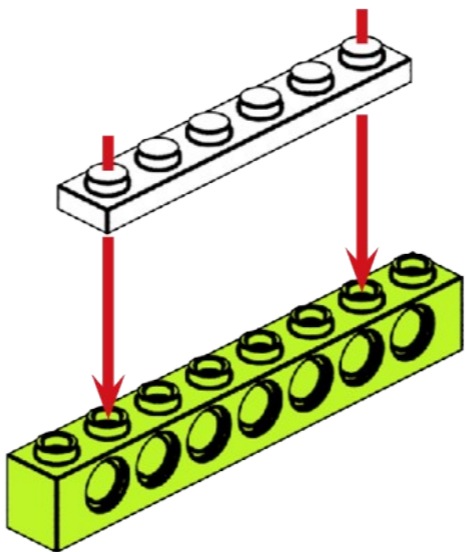

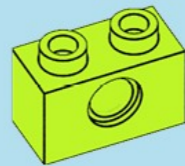
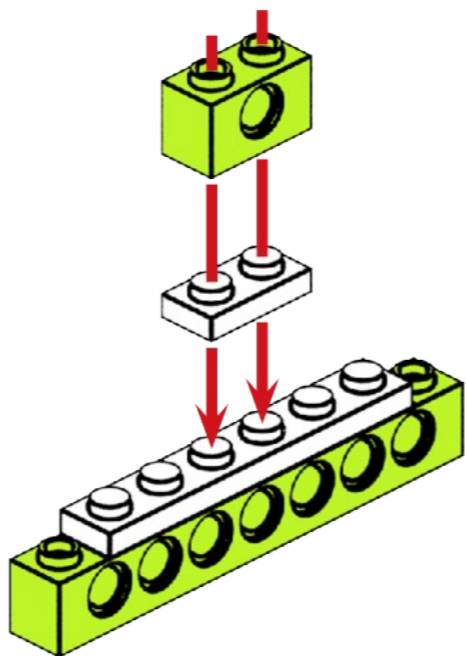

x1

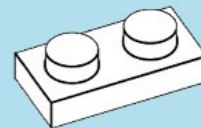

x1

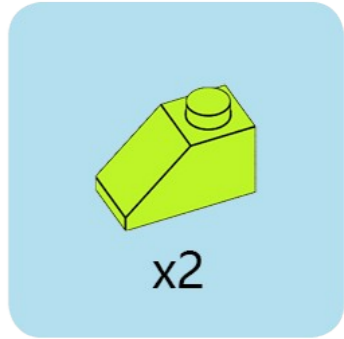
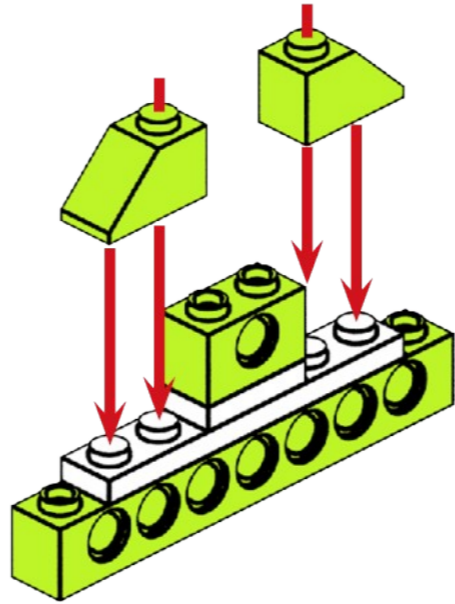

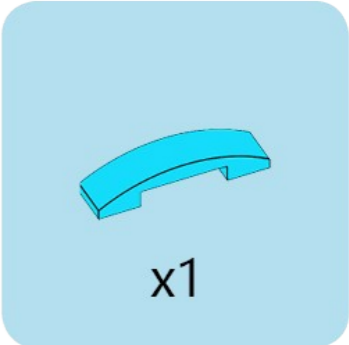
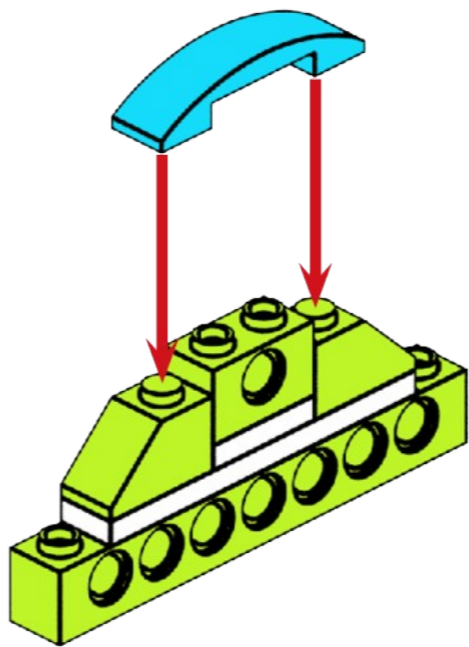

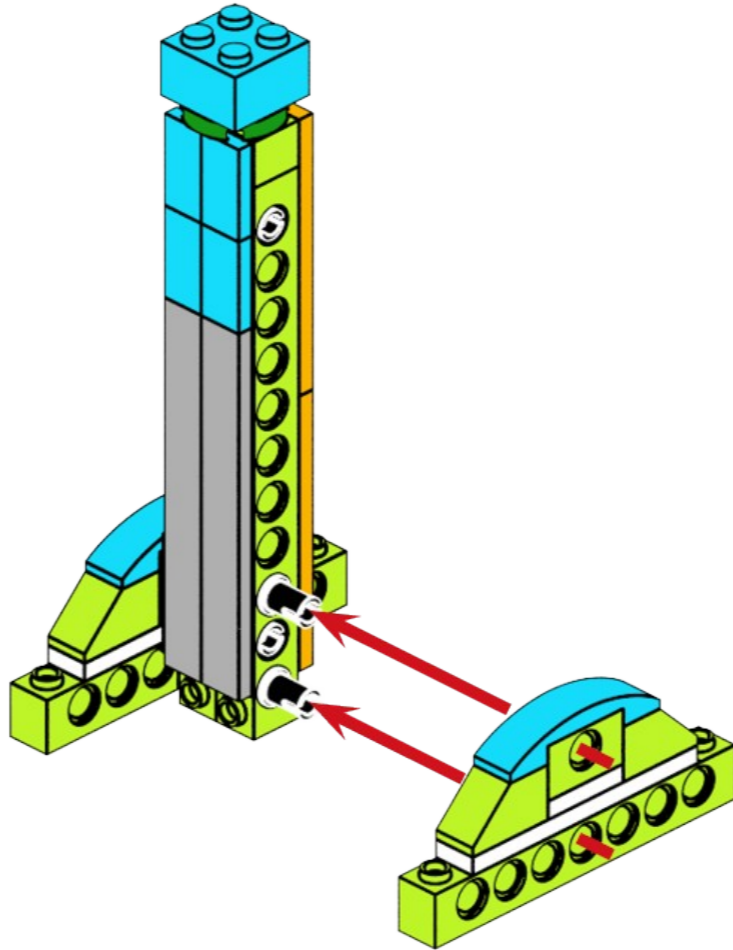

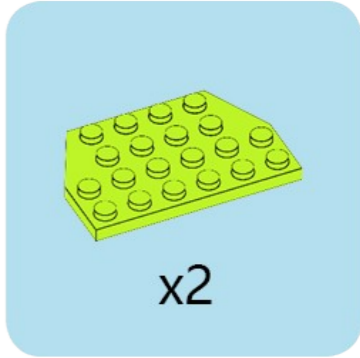
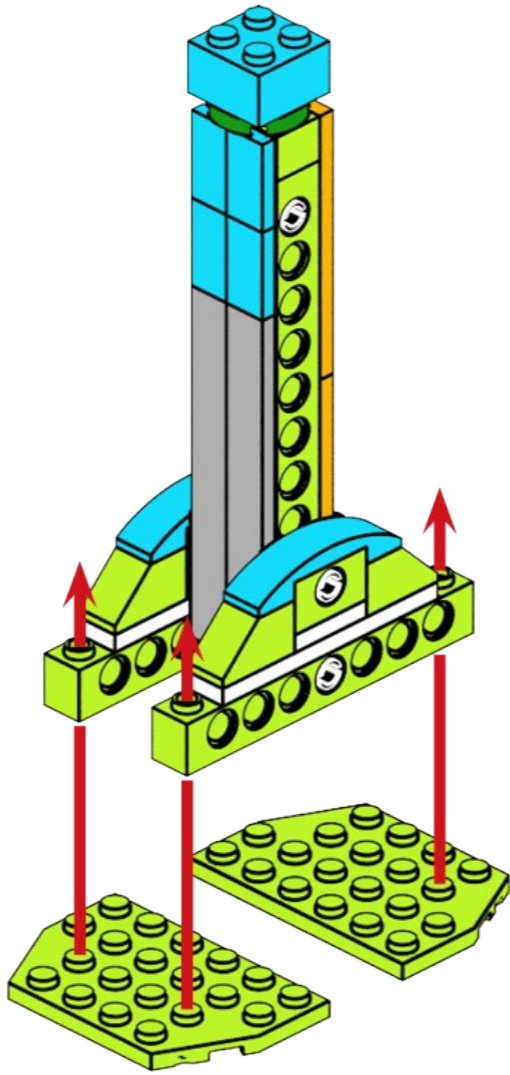
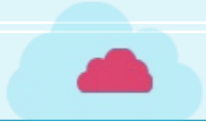

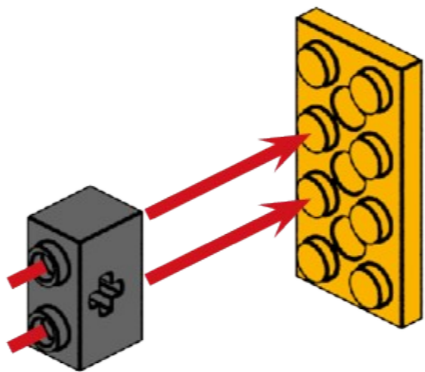
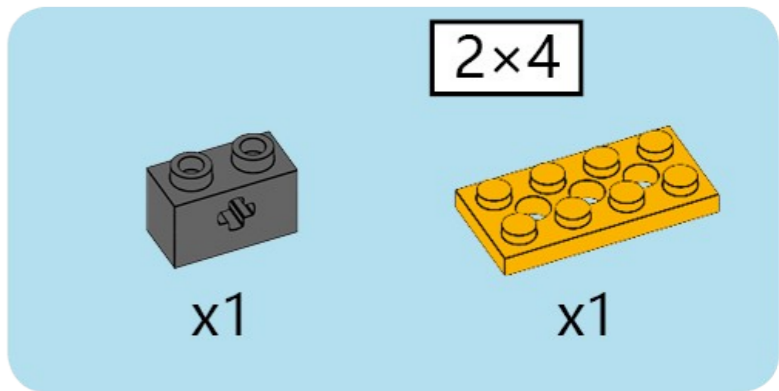

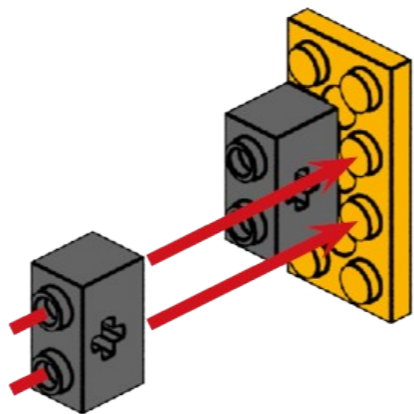
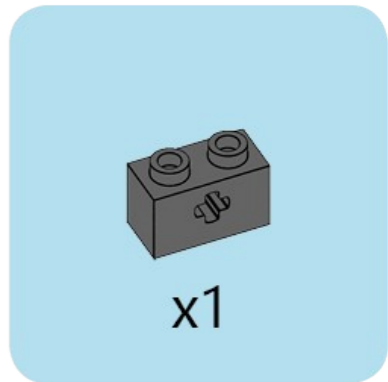

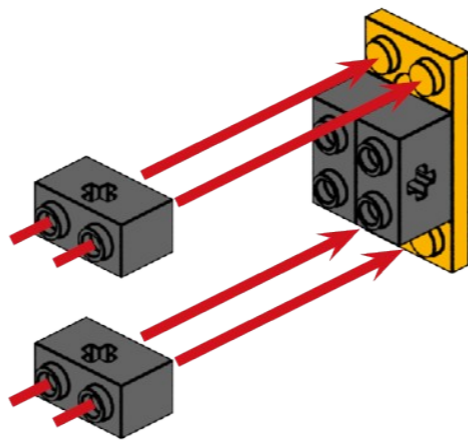
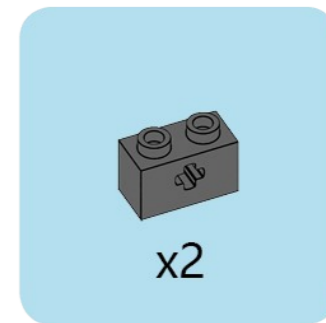

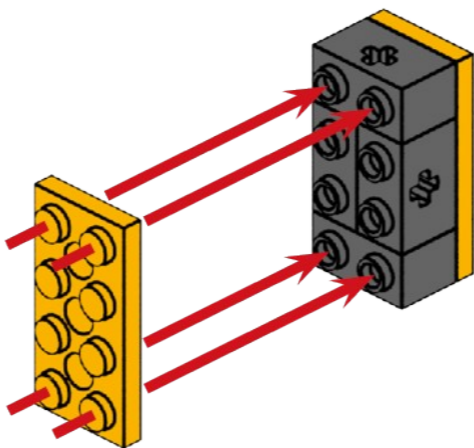
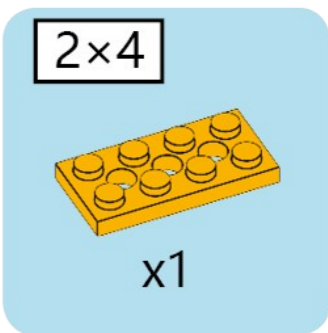

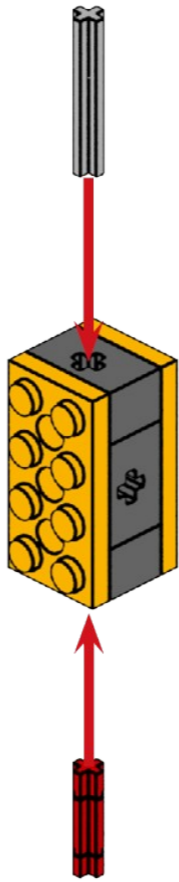
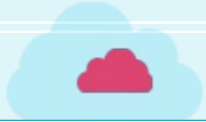

2



x1

3

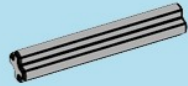

x1

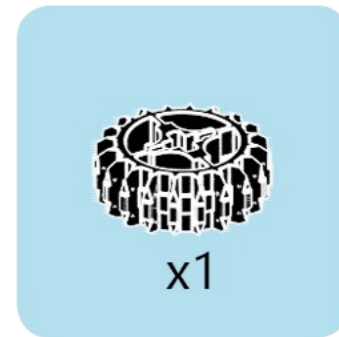
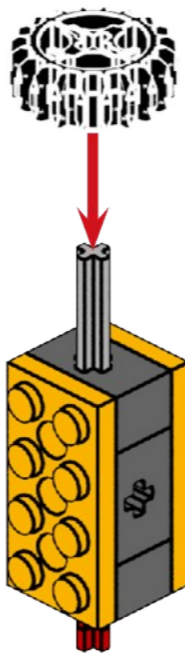

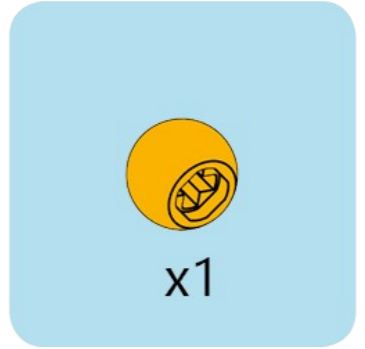

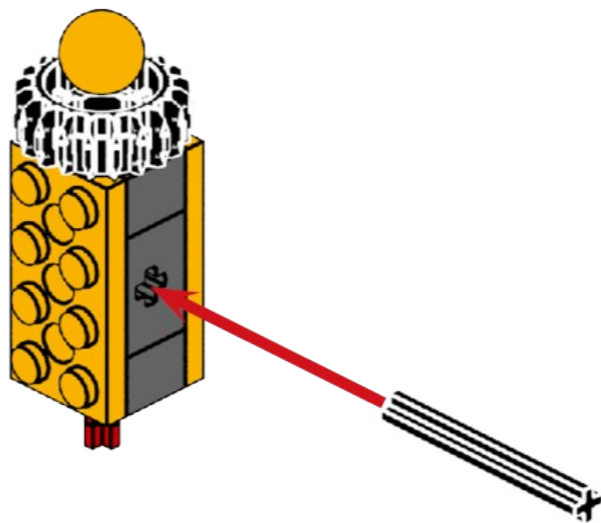
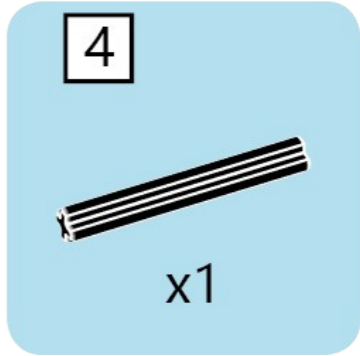

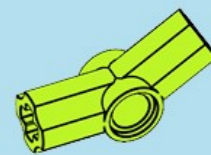
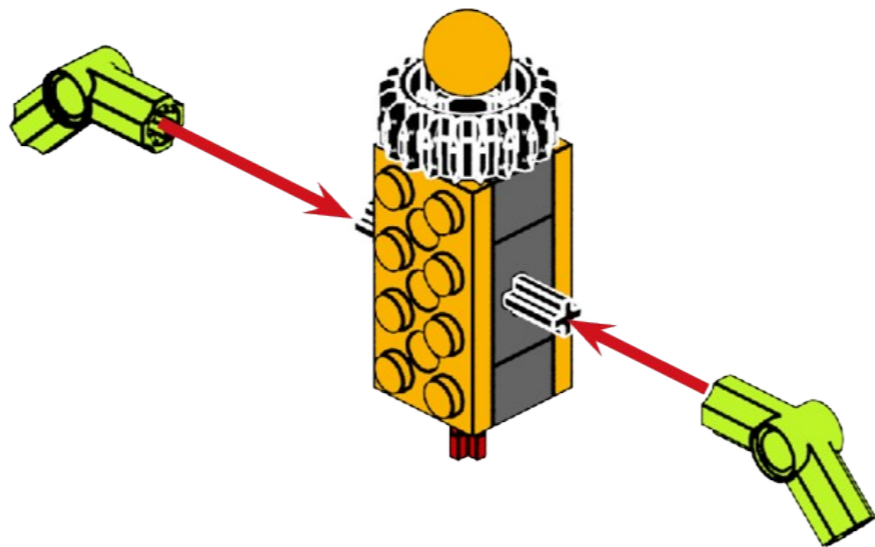

x2

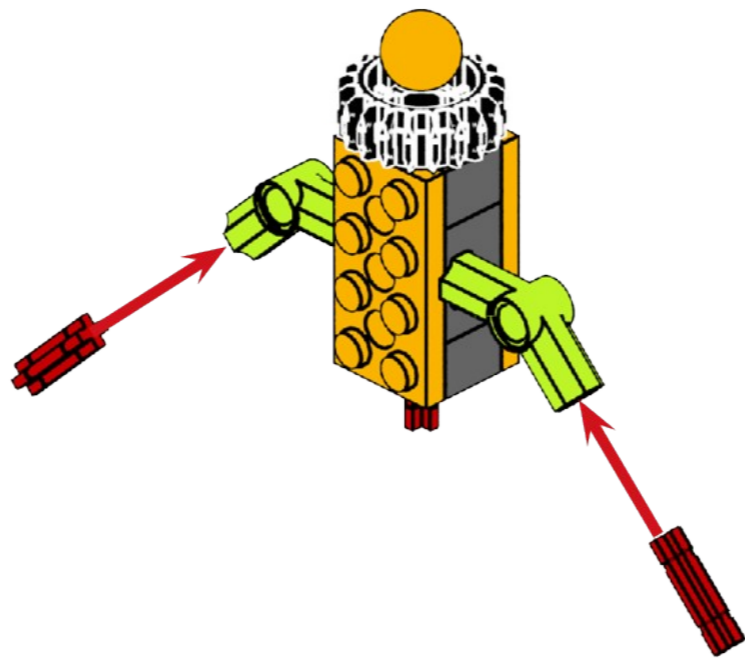

2

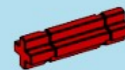

x2

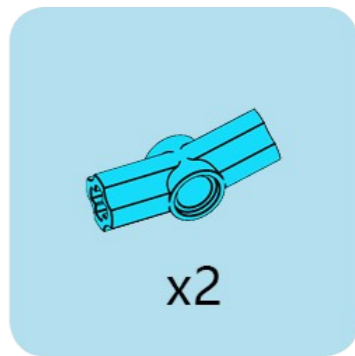
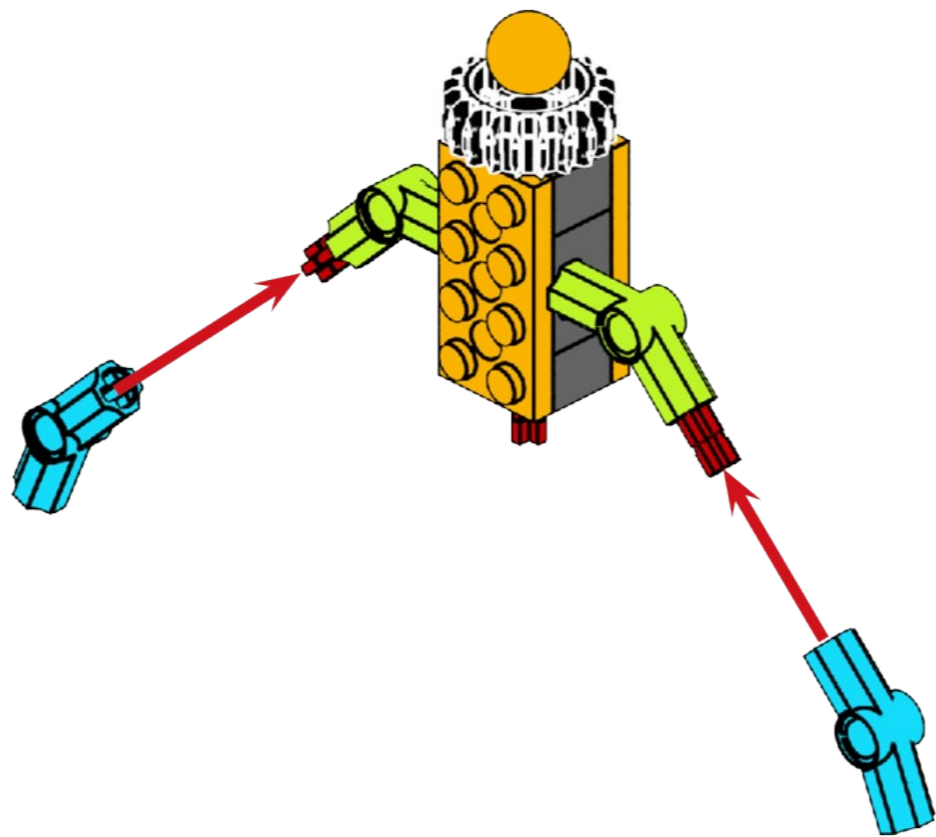

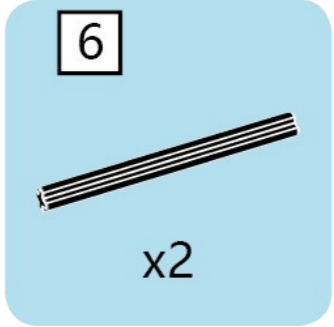
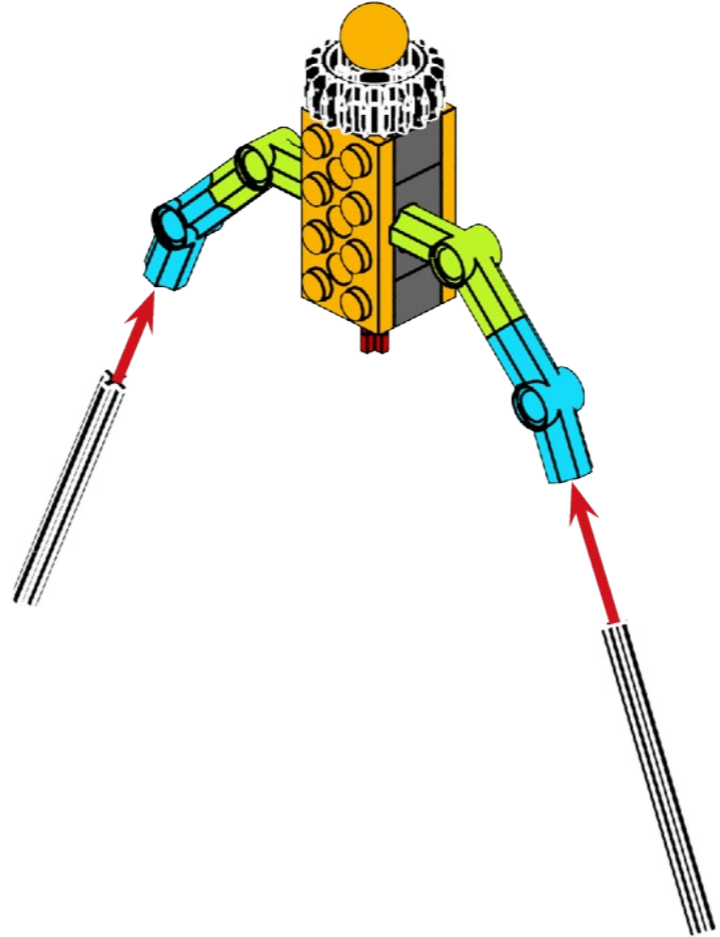

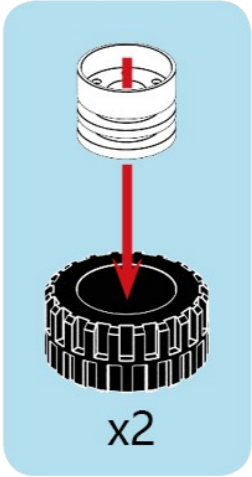
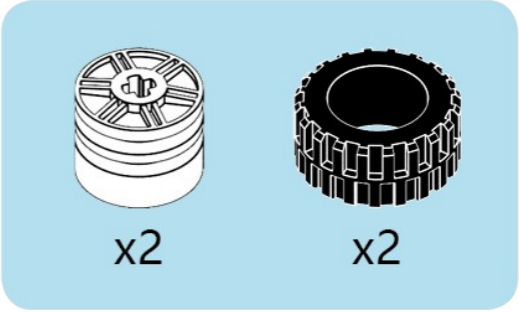
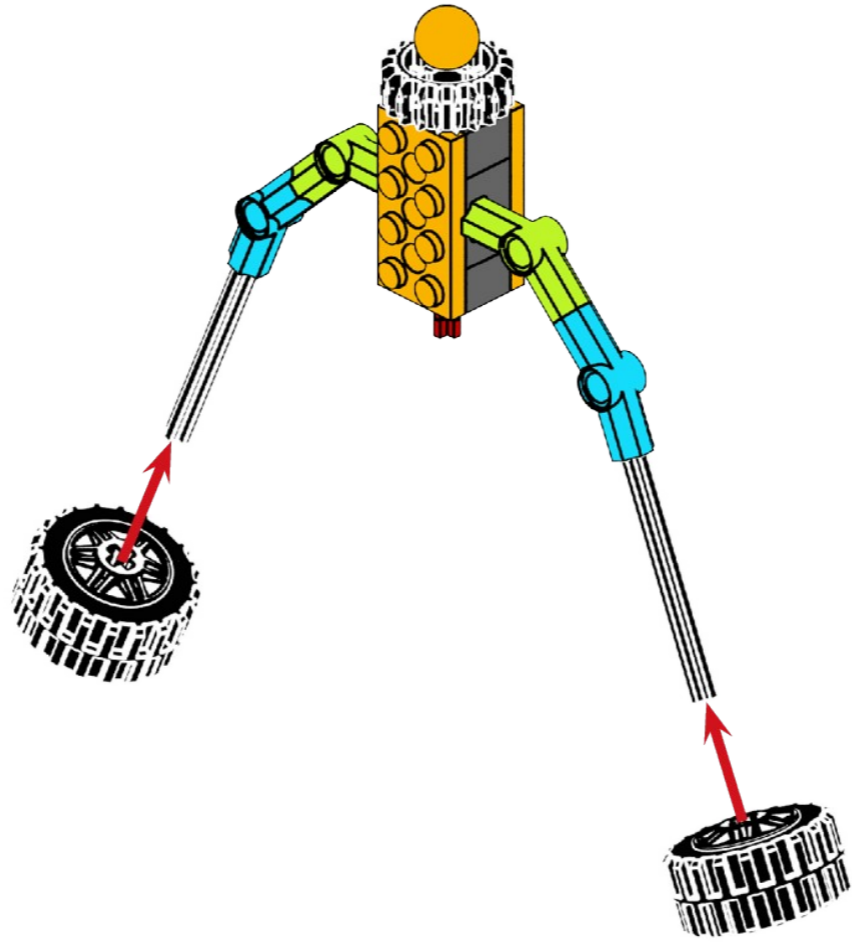

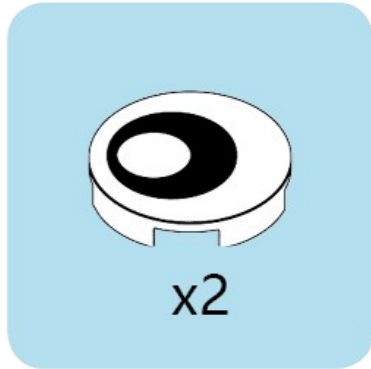
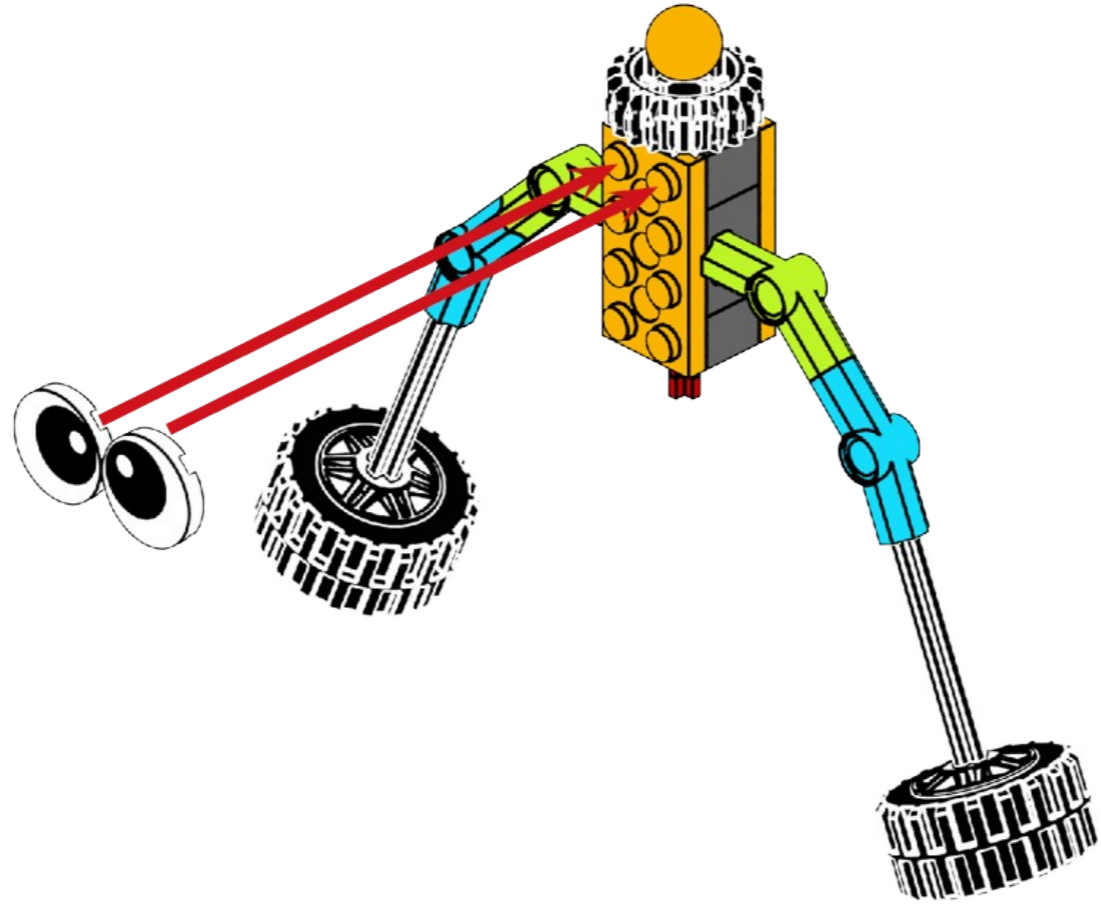
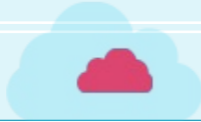

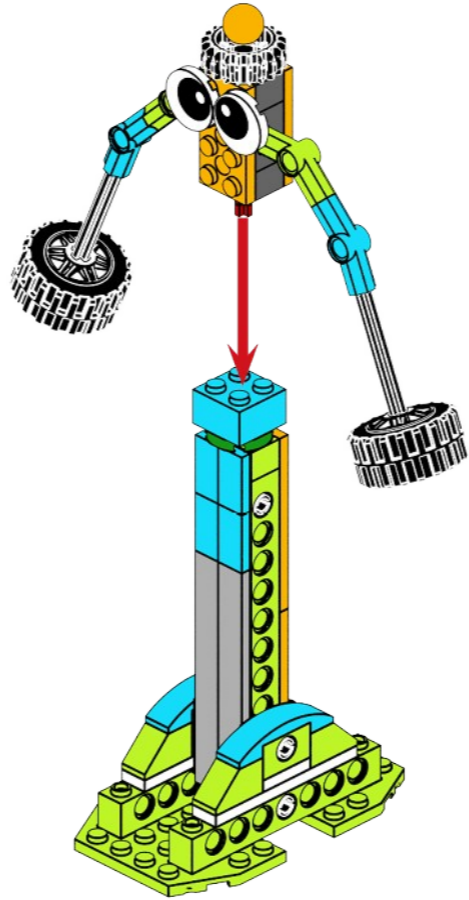

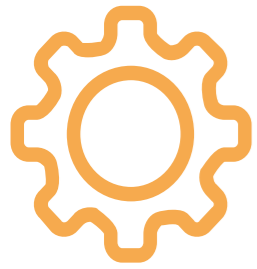

Review

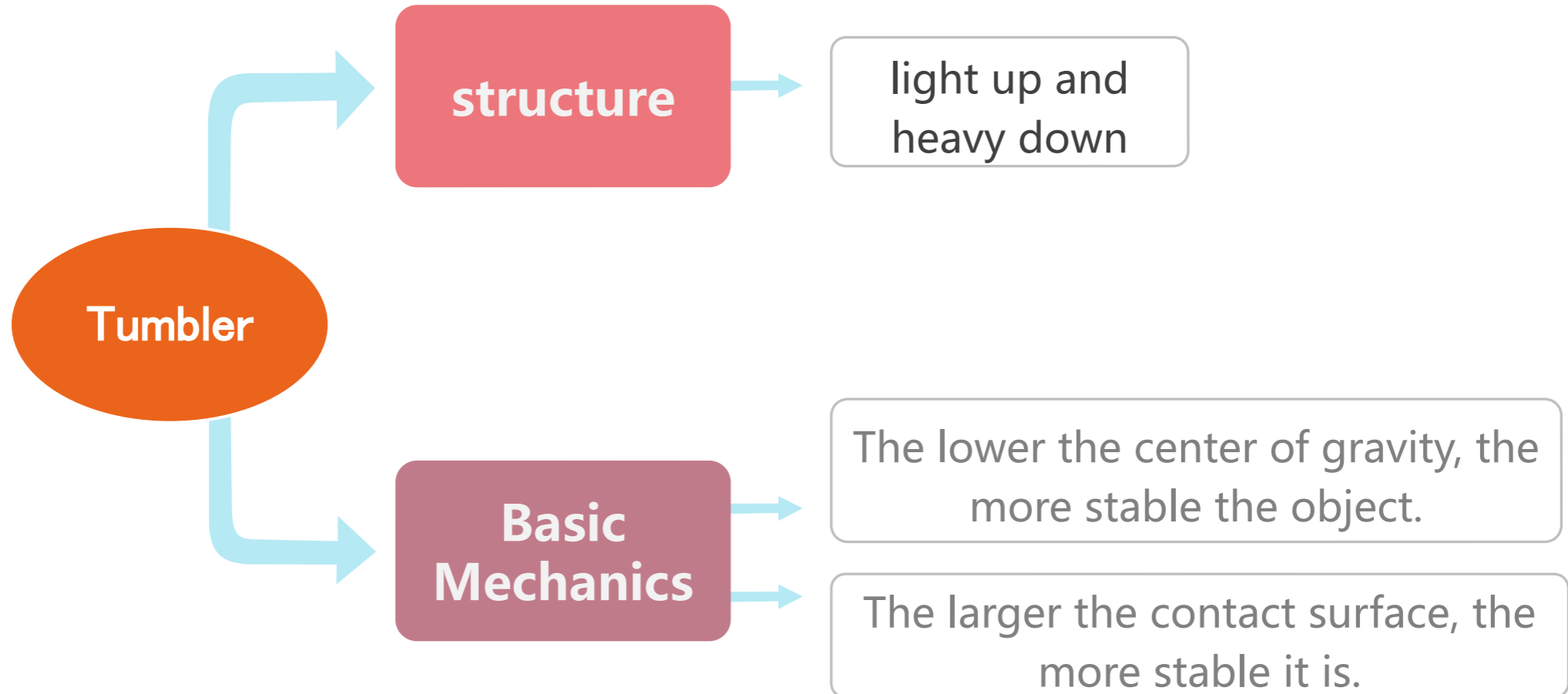



Talk





THANKS

